

UMS-6202/8202  
First Edition  
January 2004

**Summary Operating Manual**  
for  
***Models V-6202/V-8202***  
**TFT Color LCD**  
**Dual Frequency Fish Finders**



*Japan Marina Co., Ltd.*

36-2-1001 UDAGAWA-CHO, SHIBUYA-KU, TOKYO 150-0042, JAPAN  
PHONE: (03)3461-3606 FAX: (03)3496-2078

[www.japan-marina.co.jp](http://www.japan-marina.co.jp)      [sales@japan-marina.co.jp](mailto:sales@japan-marina.co.jp)

< WARNING >

**TO PREVENT POSSIBLE DAMAGE TO THE EQUIPMENT, YOU MUST NOT USE A POWER CORD OTHER THAN THE ONE SUPPLIED STANDARD WITH THE EQUIPMENT, EVEN IF IT IS TERMINATED IN A 2-PIN PLUG THAT MATES WITH THE POWER RECEPTACLE ON THE REAR PANEL.**

**USE OF SUCH A CORD CAN DESTROY THE EQUIPMENT IF ITS POLARITY IS REVERSED.**

**ANY DAMAGE CAUSED BY USING AN INCORRECT POWER CORD IS SUBJECT TO OUT-OF-WARRANTY SERVICE, AND IS NOT COVERED BY THE MANUFACTURER'S WARRANTY.**

Power Cord Supplied as Standard

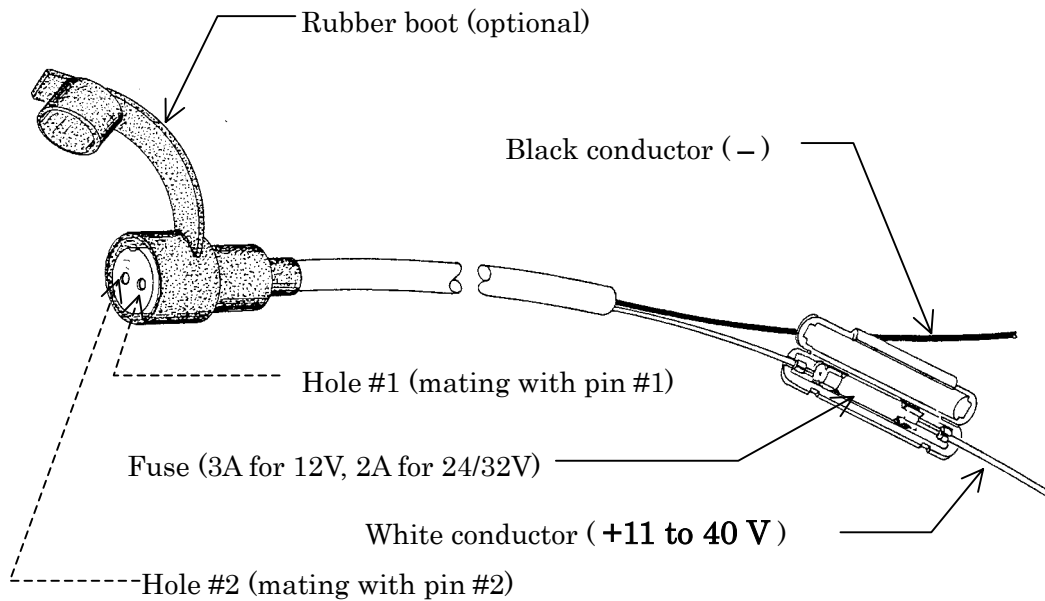

*Various onboard electronics use similar power cables, often with the opposite polarity. Lack of an in-line fuse in the cable will cause the equipment's internal electronics to be destroyed in the event of polarity reversal.*

Contents.....	Page
1. Selecting Menu Languages.....	1
2. Protection by User Password.....	2
3. Setting Mode Selection .....	4
3.1. Introduction .....	4
3.2. Terminating Advanced Setting Mode .....	4
3.3. Terminating High Sounding Rate Mode.....	4
4. Keypad Functions.....	5
5. Summary Operating Procedure.....	20
5.1. Basic Operating Procedure.....	20
5.1.1. Turning Equipment on/off.....	20
5.1.2. Adjusting Screen Brightness Level .....	20
5.1.3. Turning Keypad Backlighting on/off .....	20
5.1.4. Selecting Control Modes .....	21
5.1.5. Selecting Display Modes .....	21
5.1.6. Selecting Operating Frequencies .....	23
5.1.7. Selecting Basic Ranges.....	24
5.1.8. Selecting Expansion Ranges .....	25
5.1.9. Shifting Selected Basic Range .....	26
5.1.10. Shifting Selected Expansion Range.....	27
5.1.11. Setting Receiver Gain Level .....	27
5.1.12. Selecting Echo Dynamic Ranges .....	28
5.1.13. Setting STC Level .....	29
5.1.14. Selecting Noise Reduction (NR) Levels .....	29
5.1.15. Selecting Echogram Background Colors .....	30
5.1.16. Selecting Echo Color Assignments .....	31
5.1.17. Setting White Line Level .....	32
5.1.18. Setting Echo Threshold Level.....	33
5.1.19. Selecting Depth Readout Units .....	34
5.1.20. Selecting Digital Depth Readout Fonts.....	34
5.1.21. Turning on/off A-Scope Display.....	34
5.1.22. Setting Transducer Draft.....	35



5.1.23.	Selecting Velocity Standard for Freshwater Operation .....	35
5.1.24.	Using Variable Range Marker (VRM) .....	35
5.1.25.	Selecting Temperature Readout Units .....	36
5.1.26.	Making Depth Alarm Settings .....	36
5.1.27.	Making Fish Alarm Settings .....	37
5.1.28.	Selecting Echogram Feed Rates .....	38
5.1.29.	Selecting Screen Split Modes .....	39
5.1.30.	Storing Echogram Pages and Recalling Stored Echogram Pages .....	39
5.1.31.	Entering Man-Overboard (MOB) Point .....	40
5.1.32.	Selecting Types of Navigational Data To Be Displayed .....	42
5.2.	Advanced Operating Procedure .....	44
5.2.1.	Introduction .....	44
5.2.2.	Enabling Advanced Setting Mode .....	44
5.2.3.	Activating Advanced Setting Mode .....	45
5.2.4.	Selecting Echogram Feed Rates .....	46
5.2.5.	Setting Receiver Gain Level .....	47
5.2.6.	Setting STC Level .....	49
5.2.7.	Setting Noise Reduction (NR) Level .....	50
5.2.8.	Setting Echo Dynamic Range (D.RNG).....	51
5.2.9.	Switching Operating Frequencies.....	52
5.2.10.	Setting Echo Threshold Level.....	52
5.2.11.	Setting White Line Level .....	53
5.2.12.	Changing Echo Color Assignments .....	54
5.2.13.	Selecting Screen Background Colors .....	55
5.2.14.	Selecting Basic Ranges across Split Display .....	57
5.2.15.	Phasing Up/Down Basic Range across Split Display.....	60
5.2.16.	Selecting Display Modes on Main Display .....	62
5.2.17.	Shifting the Partition .....	65
5.2.18.	Operation in High Sounding Rate Mode .....	66
6.	Electrical Connections .....	77
6.1.	Introduction .....	77
6.2.	Power Supply Connections .....	77
6.2.1.	Power Supply Requirements .....	77
6.2.2.	Connections .....	77

6.2.3.	Power Cord Routing .....	78
6.2.4.	Installing the Fuse .....	78
6.2.	Grounding the Display Cabinet .....	78
6.3.	Connections to the Transducer .....	79
6.4.	Connections to NMEA-0183 .....	80
6.4.1.	Introduction .....	80
6.4.2.	Types of Data To Be Transferred .....	80
6.4.3.	Connector Pin Assignments .....	80
6.4.4.	Connecting an External GPS Sensor .....	81
6.5.	Connecting Water Temperature Sensor .....	82
7.	Installation .....	83
7.2.	Display Cabinet Installation .....	83
7.2.1.	General Precautions .....	83
7.2.2.	Installation Site Requirements .....	83
7.2.3.	Installation .....	83
7.3.	Transducer Installation .....	85
7.3.1.	Introduction .....	85
7.3.2.	Matched Transducer .....	85
7.3.3.	Installation Location .....	85
7.3.4.	Transducer Dimensions .....	88

## 1. Selecting Menu Languages

A menu system is incorporated in this equipment to allow you to customize the operation to your actual operational requirements. The menu options are initially indicated in English, and can be displayed in several local languages.

The desired language can be selected via the following steps:  
(Observe < **CAUTION** > below)



Turn the equipment on by lightly touching  while holding down .

The following menu will then be displayed. Note that the option selected is indicated in red.

Figure 1-1 Language Menu – Example

LANGUAGE MENU
<b>1:ENGLISH</b>
2:SPANISH
3:VIETNAMESE
4:BAHASA MALAYSIA
5:CHINESE (中文)
6:THAI
7:DANISH
8:KOREAN

*The menu show at left is an example. The number of languages supported is subject to change with the software version.*

Select the desired language by repeatedly pressing  or .

Selection of some languages, such as Vietnamese and Thai, requires entry of a specific password. Ask your dealer for assistance.

Press  to complete the selection.

The language menu will then be turned off automatically, followed by the appearance of echogram across the full screen area.

### < CAUTION >

**Executing the above procedure will reset the echo sounder system, clearing the user memory. Previous echogram pages stored in memory will be lost.**

#### To protect the user memory

To reset the system while protecting the user memory, turn the equipment on while holding down .

## 2. Protection by User Password

To prevent unauthorized use of this equipment, you can set a numeric password of your choice via the procedure described below after choosing the desired menu language.

### < CAUTIONS >

1. **Be sure to choose a password you can easily recall at a later time, and take a note of it somewhere just in case you forget it.**
2. **Once a password is set, neither the manufacturer nor your dealer will be responsible for a failure to bring the equipment into operation due to entry of a wrong password.**
3. **Set a password at your own risk. The password you set cannot be changed.**



- (1) Turn the equipment off, and then turn it on again while holding down both  and  simultaneously until a password entry window shows up.

Figure 2-1 Setting Password – Step 1



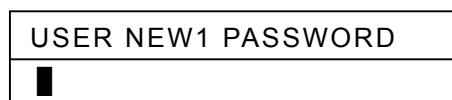

- (2) Using the numeric keys described below, enter a desired password that consists of 4 (minimum) to 8 (maximum) numerals. Entry mistakes can be erased by pressing  / .

Figure 2-2 Setting Password – Step 2

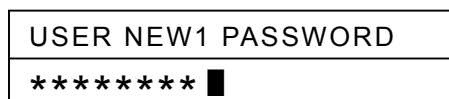











Table 2-1 Numeric Key Assignments

Key	Number to Enter	Key	Number to Enter
	1		2
	3		4
	5		6
	7		8
	9		0

*NOTE: These numeric assignments can be used also to select menu options.*

*(continued on next page)*

## 2. Protection by User Password (continued – 2/2)

- (3) Press **ENT**. Another password entry window should then show up, asking you to key in the same password numbers. This procedure is to make it sure that you remember the password.

Figure 2-3 Setting Password – Step 3

USER NEW2 PASSWORD
█

- (4) Enter the same password again.

Figure 2-4 Setting Password – Step 4

USER NEW2 PASSWORD
***** █

If an incorrect password is entered, the above window will be redisplayed. You can cancel the password setting at this step by switching the equipment off.

- (5) Press **ENT**. A password window should then show up, indicating that the system has accepted the setting of your password.

Figure 2-5 Password Window

ENTER PASSWORD
█

- (6) Enter the same password again and press **ENT**. The screen will then be replaced by a normal echogram display.

Figure 2-6 Entering User Password

ENTER PASSWORD
***** █

The above password window will show up after each power-up.

### 3. Setting Mode Selection

#### 3.1. Introduction

The following modes of setting can be selected to change various control parameters (depth range, phased range, echo color assignment, gain, STC, echogram feed rate, etc.)

Normal Setting Mode (ref. paragraph 5.1)







When the equipment is delivered by your dealer, this is normally the initial setting. You can set the operating parameters in the same manner as on other JMC-brand echo sounders. This mode is recommended for first time users.



Advanced Setting Mode (ref. paragraph 5.2)



This mode allows you to:

- split the screen in two, and can set the control parameters separately across each display screen to customize operation to your specific requirements, and
- activate a high sounding rate mode of operation suitable for fish finding at shallow depths on a high speed boat.

To enable you to activate this setting mode, execute the following keystrokes:

- (1) Press  to open the main menu, and select “7:MODE” by pressing .
- (2) Select “2:ADVANCED MODE” by pressing , and then “2:ON” by pressing  again.
- (3) Close the menus by pressing .
- (4) Press and hold down either of the following keys for two seconds or more to activate the desired mode:
  -  to activate the advanced setting mode. The screen will be split in two.

To select operating parameters across each screen, press  first. Then, select the main display (**MAIN DISP**) or customizable display (**CTM DISP**) with  / .

The parameters on the selected menu (with its title shown in red) can now be changed with  / .

-  to activate the high sounding rate mode. (ref. paragraph 5.2.18)

#### 3.2. Terminating Advanced Setting Mode

To terminate the advanced setting mode, press  for two seconds or longer again.

#### 3.3. Terminating High Sounding Rate Mode

To terminate the high sounding rate mode, press  for two seconds or longer again.

## 4. Keypad Functions

The figure below illustrates the control keypad of the **V-6202** echo sounder. A summary description of the functions the keys provide is given below and in the following pages.

Figure 4-1 Keypad of V-6202

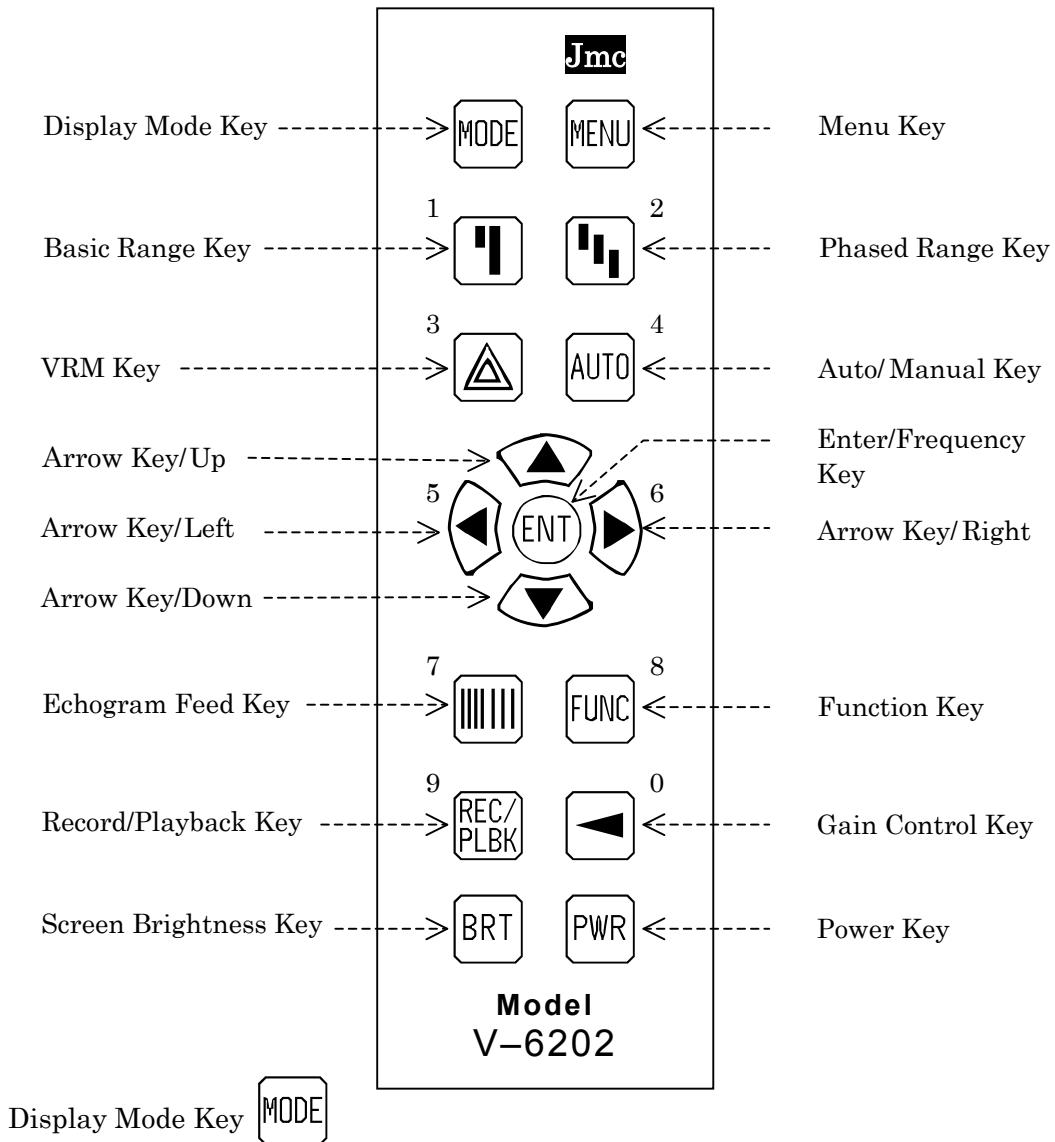

Repeated keypress selects the following display modes in sequence:

- Single frequency full screen display
- Single frequency split screen display with pelagic expansion (zooming)
- Single frequency split screen display with bottom-locked scale expansion
- Dual frequency split screen display



When a number of menus are being shown, pressing this key closes all menus at a time, returning you to the normal echogram screen.

#### 4. Keypad Functions *(continued - 2/15)*

Menu Key 

Pressing this key opens a main menu as shown below, through which you can make various settings to customize the operation of the equipment to suit your own applications.

Figure 4-2 Main Menu

- Menu options can be selected by pressing appropriate numeric keys, or  /  followed by .
- The option selected is shown in red.
- When a submenu is being shown, pressing this key returns you to the previous menu or to the echogram screen.

MENU
<b>1:DISPLAY</b>
2:ALARM
3:DEPTH
4:DRAFT
5:DIMMER
6:TEMPERATURE
7:MODE

A summary description of each option is given below.

- 1:DISPLAY:** Turns on/off A-scope display, selects screen splitting modes (vertical/horizontal), turns on/off GPS-derived data\* (LAT/LON, speed, MOB, etc.), and selects echo/background colors.
- 2:ALARM:** Selects depth alarm modes (shallow/deep), and sets fish alarm parameters.
- 3:DEPTH:** Selects depth readout units (meters, fathoms, etc.), depth readout font sizes (large/small), and velocity standards (sea/fresh water).
- 4:DRAFT:** Enters transducer draft to read depth from waterline.
- 5:DIMMER:** Turns on/off keypad backlighting.
- 6:TEMPERATURE:** Selects water temperature readout units (°C/°F)\*\*.
- 7:MODE:** Selects the following two options:
- **1:SIMULATION:** Turns on/off built-in sounder simulator.
  - **2:ADVANCED MODE:** Enables you to activate advanced mode of settings for faster sounding rate or for independent settings of various operating parameters (depth ranges, echo colors, echo threshold level, echo dynamic range, STC level, etc.) across split screen displays. See paragraphs and for more details.

\* *Optional GPS sensor or NMEA-0183 format GPS data input is required.*



\*\* *Optional T-300 temperature sensor is required.*

#### 4. Keypad Functions (continued – 3/15)

Basic Range Key 

##### On full screen echogram display



Pressing this key assigns the function of selecting basic ranges to the following arrow keys when operating the equipment in the manual control mode\*:

-  : Selects smaller ranges (e.g. 20 15 10 7 5 3 m)
-  : Selects larger ranges (e.g. 3 5 7 10 15 20 m)

\* *The manual control mode can be turned on by lightly touching*  .

##### On split screen expansion display

To change the range on the expansion echo display, execute the following steps:

- (1) Press  twice so that the white-colored range scale lines and calibrating numerals on the normal echo display change to gray.
- (2) Press  /  to select the desired range.

##### On menus/password window

This key acts as numeric key “1” to select menu option “1:” or when entering a user password.

##### Automatic Ranging



Holding down  for two seconds more activates the automatic ranging mode (**AUTO RANGE**), displaying the bottom echo in the lower half screen (or at an appropriate position within the screen) by automatically changing the basic range.

To terminate the function, lightly touch the key again.

Phased Range Key 

##### On full screen echogram display

Pressing this key assigns the function of shifting (phasing up/down) the basic range in use to the following pair of arrow keys when operating the equipment in the manual control mode\*:

-  : Shifts the range in shallowing direction (toward the surface).
-  : Shifts the range in deepening direction (toward the bottom).

\* *The manual control mode can be turned on by lightly touching*  .



(continued on next page)

#### 4. Keypad Functions *(continued - 4/15)*

Phased Range Key  *(continued - 2/2)*

##### On split screen expansion display

To change the range on the expansion echo display, execute the following steps:

- (1) Press  twice so that the white-colored range scale lines and calibrating numerals on the normal echo display change to gray.
- (2) Then, press  /  to shift the expansion range to the desired depth.

##### On menus/password window

This key acts as numeric key “2” to select menu option “**2:**” or when entering a user password.

##### Automatic Ranging

Holding down  for two seconds more activates the automatic range shift mode (**AUTO SFT**), displaying the bottom echo in the lower half screen (or at an appropriate position within the screen) by automatically shifting up/down the basic range in use. To terminate the function, lightly touch the key again.

VRM Key (Variable Range Marker Key) 

Pressing this key turns on the VRM to the left of the scale lines. A second keypress turns it off. The VRM can be shifted with the following pair of arrow keys:





-  : Shifts the marker in shallowing direction (toward the surface).
-  : Shifts the marker in deepening direction (toward the bottom).

Figure 4-3 VRM – Example

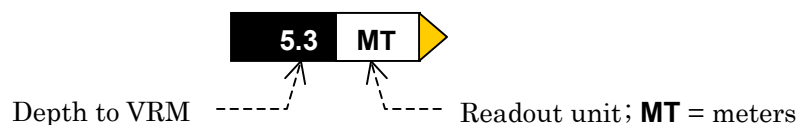

##### Activating Depth Alarm

Pressing  sets the alarm depth at the VRM position, and enables the depth alarm function to warn against decreasing or increasing depth.

To turn the alarm function off, press  again.

##### On menus/password window

This key acts as numeric key “3” to select menu option “**3:**” or when entering a user password.

*(continued on next page)*

#### 4. Keypad Functions *(continued – 5/15)*

Auto/Manual Key 





Pressing this key selects the following control modes in sequence:

- **FULL AUTO:** Activates the fully automatic control mode of operation, automatically selecting basic ranges and adjusting receiver gain and STC levels so that the bottom echo shows in red at all times either in the lower half screen area or at an appropriate position within the screen, depending on the current range settings.
- **MANUAL:** Allows manual selection of basic ranges, receiver gain and STC levels.

This key acts as numeric key “4” to select menu option “4:” or when entering a user password.

Pressing this key for two seconds or longer activates the advanced setting mode\*, splitting the echogram screen in two for separate settings\*\* of depth range, gain and STC levels, echo and background colors, dynamic range, etc.

\* *To enable the advanced setting mode, execute the following steps:*

- (1) Press  to open the main menu, and select “7:MODE” by pressing .
- (2) Select “2:ADVANCED MODE” by pressing , and then “2:ON” by pressing  again.
- (3) Close the menus by pressing .

\*\* *Separate parameter settings can be made via the following steps:*







- (1) Press , turning on two control menus (**MAIN DISP** and **CTM DISP**), which correspond to the right and left half displays, respectively.
- (2) Press  or  to choose the display on which you wish to change the settings.
- (3) The parameters shown on the selected menu (with its title shown in red) can then be changed by pressing  / .
- (4) Close the two menus by pressing .

Figure 4-4 Parameter Setting Menus for Advanced Setting Mode – Example

CTM DISP	MAIN DISP	
PF = 2/1	PF = 1/1	PF = Echogram feed rate
GAIN = 40	GAIN = MAX	GAIN = Receiver gain level
STC = 0	STC = 4	STC = Initial gain suppression level
NR = OFF	NR = OFF	NR = Noise reduction level
D.RNG= 3dB	D.RNG= 6dB	D.RNG = Echo dynamic range

*(continued on next page)*

#### 4. Keypad Functions *(continued - 6/15)*

Arrow Key/Up 

Pressing this key performs one of the following functions:

Selects smaller basic ranges or shifts the current basic range upward when the manual control mode of operation is activated. See paragraph just above.

Selects smaller bottom expansion ranges or shifts the pelagic expansion range upward.

Shifts the VRM upward when the VRM is turned on. See paragraph .

Enters numeric values when setting the transducer draft.

Selects menu options upward when a menu is being opened.

Increases echogram feed speed, receiver gain level, STC level, noise reduction (NR) level, etc. when the control menu is being opened by pressing  . See paragraph for related information.

Enter/Frequency Key 

Full screen single frequency display

Pressing this key changes the operating frequency from 50 kHz to 200 kHz or vice versa.

Split screen dual frequency display

Pressing this key switches the frequencies of the right-hand and left-hand displays, as illustrated below.

Figure 4-5 Switching Operating Frequencies in Dual Frequency Operation

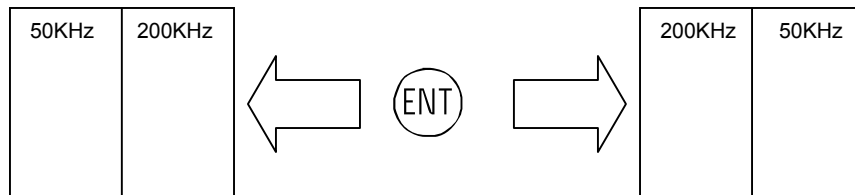

Advanced setting mode display

Pressing this key changes the frequency of the **MAIN DISP** screen only.

Pressing this key completes the selection of menu option or data entry when a menu is being opened.

Pressing this key for two seconds or longer stores the present position coordinates when an optional GPS sensor is plugged into, or GPS position data are input from external GPS equipment through, the rear panel I/O DATA connector. The stored data plus the distance and bearing to that point can be recalled via path: **MENU 1:DISPLAY 3:GPS DATA 4:ON(MOB)**.

Turning the equipment on while holding down this key resets the system software, returning all user-made settings to the initial values and clearing the user memory that stores past echogram pages. See section 1 “**Selecting Menu Languages**” for details.

*(continued on next page)*

#### 4. Keypad Functions (continued – 7/15)

Arrow Key/Left



This key acts as numeric key “5” to select menu option “5:” or when entering a user password.

##### Normal Setting Mode

When the control menu is being opened (by pressing **FUNC**), pressing this key opens an additional menu from which you can set the echo threshold (**T.HOLD**), white line (**W.LINE**), or select echo colors (**ECO.COLOR**) and background colors (**BG.COLOR**). See paragraph for more details.

Figure 4-6 Control Menus for Normal Setting Mode – Example

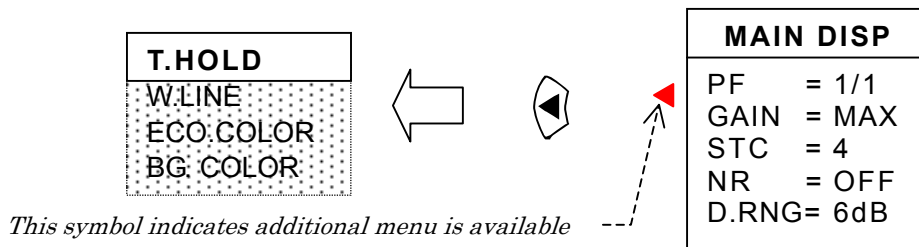

##### Advanced Setting Mode

When the advanced setting mode\* is activated to split the screen into right and left halves for separate settings of gain, depth range, etc., pressing this key shifts the partition to the left.

\* See paragraph for procedure to activate the advanced setting mode.

When the two control menus (**CTM DISP** and **MAIN DISP**) are displayed (by pressing **FUNC**), pressing this key selects the **CTM DISP** menu to allow you to change the operating parameters across the left-hand display.

Figure 4-7 Selecting **CTM** Menu and Accessing Its Additional Menu – Example

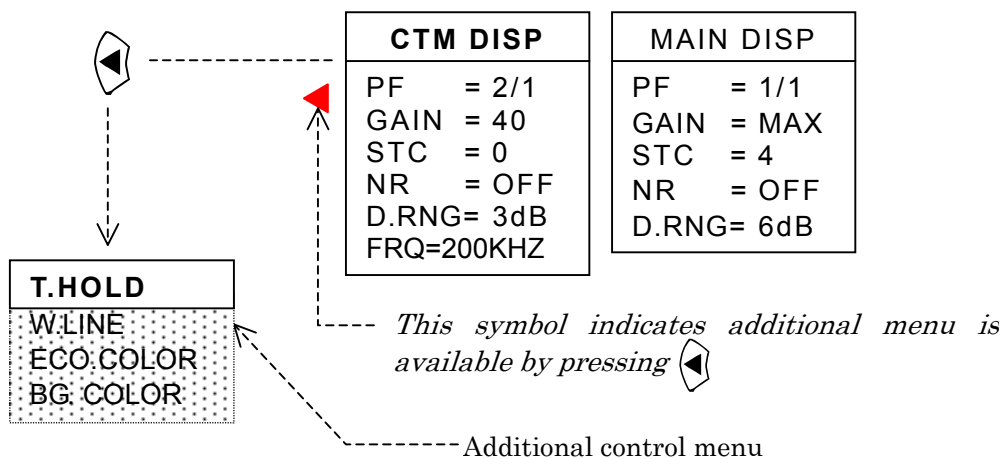

A second keypress opens an additional control menu hidden behind the **CTM DISP** menu, as in the example above.

(continued on next page)

#### 4. Keypad Functions *(continued – 8/15)*



Arrow Key/Left  *(continued – 2/2)*

When the high sounding rate mode of operation\* is activated to split the screen in two, pressing this key shifts the partition to the left.

\* *The high sounding rate of operation can be activated by holding down  for two seconds or longer after enabling the advanced setting mode via path: **MENU 7:MODE 2:ADVANCED MODE 2:ON.***

When reviewing\* stored echogram\*\* pages, pressing this key selects those pages one by one at a time, the latest one first, or scrolls through the pages continuously depending on the playback mode selected.

\* *The stored pages can be reviewed by holding down  for two seconds or more, and then by selecting the desired playback mode (**PAGE BY PAGE** or **CONTINUOUS**) on the **PLAYBACK MODE** menu. See paragraph for details.*

\*\* *The current echogram can be stored by lightly touching , followed by . See paragraph for details.*



*(continued on next page)*

#### 4. Keypad Functions (continued – 9/15)

Arrow Key/Right 

This key acts as numeric key “6” to select menu option “6:” or when entering a user password.

##### Normal Setting Mode

When the additional control menu is being opened (by pressing , followed by , pressing this key closes that menu to allow the user to change the parameters on the **MAIN DISP** menu.

##### Advanced Setting Mode

When the advanced setting mode\* is activated to split the screen into right and left halves for separate settings of gain, depth range, etc., pressing this key shifts the partition to the right.

\* See paragraph for procedure to activate the advanced setting mode.



When the two control menus (**CTM DISP** and **MAIN DISP**) are displayed (by pressing , pressing this key selects the **MAIN DISP** menu to allow you to change the operating parameters across the right-hand display.

Figure 4-8 Selecting **MAIN DISP** Menu and Accessing Its Additional Menu

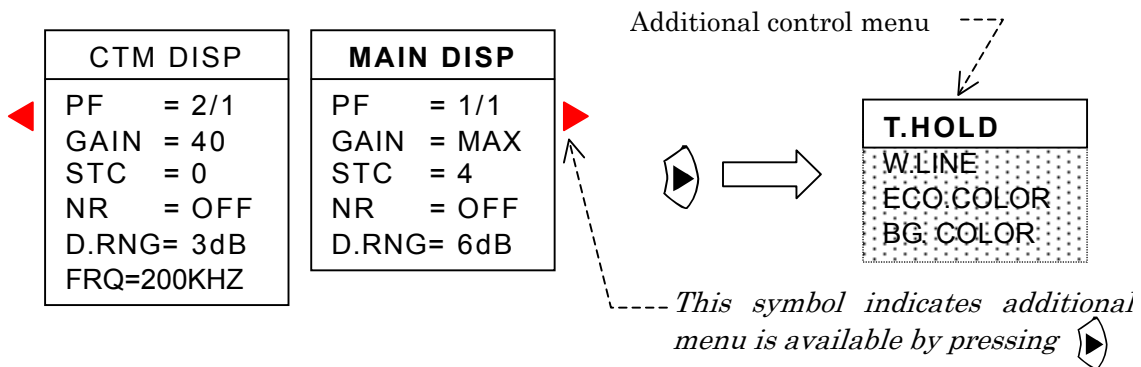

A second keypress opens an additional control menu hidden behind the **MAIN DISP** menu, as in the example above.

When the high sounding rate mode of operation\* is activated to split the screen in two, pressing this key shifts the partition to the right.

\* The high sounding rate of operation can be activated by holding down  for two seconds or longer after enabling the advanced setting mode via path: **MENU 7:MODE 2:ADVANCED MODE 2:ON.**



(continued on next page)

#### 4. Keypad Functions *(continued – 10/15)*

Arrow Key/Right  *(continued – 2/2)*

When reviewing\* stored echogram\*\* pages, pressing this key selects those pages one by one at a time, the last one first, or scrolls through the pages continuously depending on the playback mode selected.

\* The stored pages can be reviewed by holding down  for two seconds or more, and then by selecting the desired playback mode (**PAGE BY PAGE** or **CONTINUOUS**) on the **PLAYBACK MODE** menu. See paragraph for details.

\*\* The current echogram can be stored by lightly touching , followed by . See paragraph for details.

Arrow Key/Down 

Pressing this key performs one of the following functions:

Selects smaller basic ranges or shifts the current basic range downward when the manual control mode of operation is activated. See paragraph .

Selects greater bottom expansion ranges or shifts the pelagic expansion range downward.

Shifts the VRM downward when the VRM is turned on. See paragraph .

Enters numeric values when setting the transducer draft.

Selects menu options downward when a menu is being opened.

Decreases echogram feed speed, receiver gain level, STC level, noise reduction (**NR**) level, etc. when the control menu is being opened by pressing . See paragraph for related information.

Echogram Feed Key 

Normal Setting Mode

Pressing this key opens a feed rate control window, such as the example below.

Figure 4-9 Feed Rate Control Window – Example

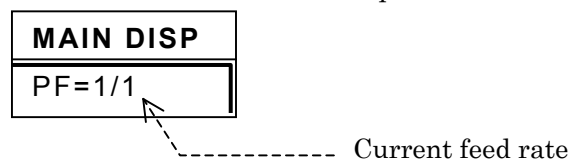

While this window is open, pressing  /  selects a total of 7 echogram feed rates or freezes the feed.

**PF=2/1** (highest rate), **PF=1/32** (lowest rate), **PF=STOP** (feed frozen)

*(continued on next page)*

#### 4. Keypad Functions (continued – 11/15)

Echogram Feed Key  (continued– 2/2)



Advanced Setting Mode\*

High Sounding Rate Mode

Holding this key down for 2 seconds or longer activates the high sounding rate mode. The screen is split\*\* in two, with the right-hand side screen showing a high feed rate echogram based on the highest sounding rate for the depth range in use.

The high rate sounding screen is suitable for applications where you are looking for fast-moving targets while traveling at high speeds.

\* The advanced setting mode can be enabled via path: **MENU 7:MODE 2:ADVANCED MODE 2:ON.**

\*\* The partition can be moved by pressing  / .

The depth range across the high sounding rate display is synchronized with the normal display. Separate range settings over both displays are not supported.





Pressing  opens a parameter setting menu (**MAIN DISP**) over the normal display and a feed rate control window (**HI. SPEED**) over the high sounding rate display, as in the example below.

Figure 4-10 Parameter Selection Menus for High Sounding Rate Operation ( Example )

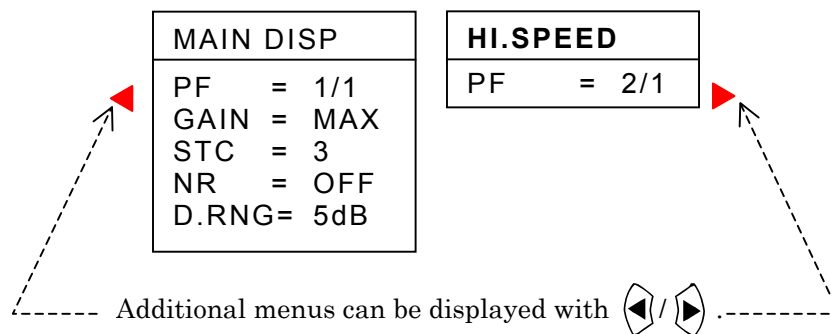

Pressing  /  selects either menu. The selected one is indicated with its title in red. Further keypress opens an additional menu hidden behind.

The parameters on the selected menu can then be selected with  /  .

This key acts as numeric key “7” to select menu option “7:” or when entering the user password.

(continued on next page)

#### 4. Keypad Functions *(continued – 12/15)*

Function Key 

Normal Setting Mode



Pressing this key opens a **MAIN DISP** menu, as in the example below, from which you can set the following control parameters:

Figure 4-11 MAIN DISP Menu – Example

- PF: Echogram (picture) feed rate
- GAIN: Receiver gain level
- STC: STC level
- NR: Noise reduction level
- D.RNG: Echo dynamic range



MAIN DISP	
PF	= 1/1
GAIN	= 25
STC	= 3
NR	= OFF
D.RNG	= 5dB

To set the desired parameter, execute the following steps:

(1) Press  /  to select the desired parameter.

(2) Press  to frame the selected parameter in red.

**GAIN = 25**

(3) Press  /  to select the desired setting level.

**GAIN = 42**

(4) Press  to turn off the menu.



Pressing  opens an additional control menu, hidden behind the MAIN DISP menu, as shown below, allowing you to set the following parameters:

Figure 4-12 Additional Control Menu



- T.HOLD: Echo threshold level
- W.LINE: White line level
- ECO.COLOR: Echo colors
- BG.COLOR: Background colors

T.HOLD
W.LINE
ECO.COLOR
BG.COLOR

To set the desired parameter, execute the following steps:

(1) Press  /  to select the desired parameter. The selected parameter is indicated in a white background.

(2) Press . The selected parameter is shown in red.

(3) Press  /  to select the desired setting level. A small window is opened below the menu to show the current level.

(4) Press  to turn off the menu.

Current setting level (example)

**7**

*(continued on next page)*

#### 4. Keypad Functions (continued – 13/15)

Function Key **FUNC** (continued – 2/2)

Advanced Setting Mode\*

Pressing this key opens two control menus (**CTM DISP** and **MAIN DISP**, as in the example below) that correspond to the left-hand and right-hand displays.

Figure 4-13 Accessing Control Menus for Advanced Setting Mode

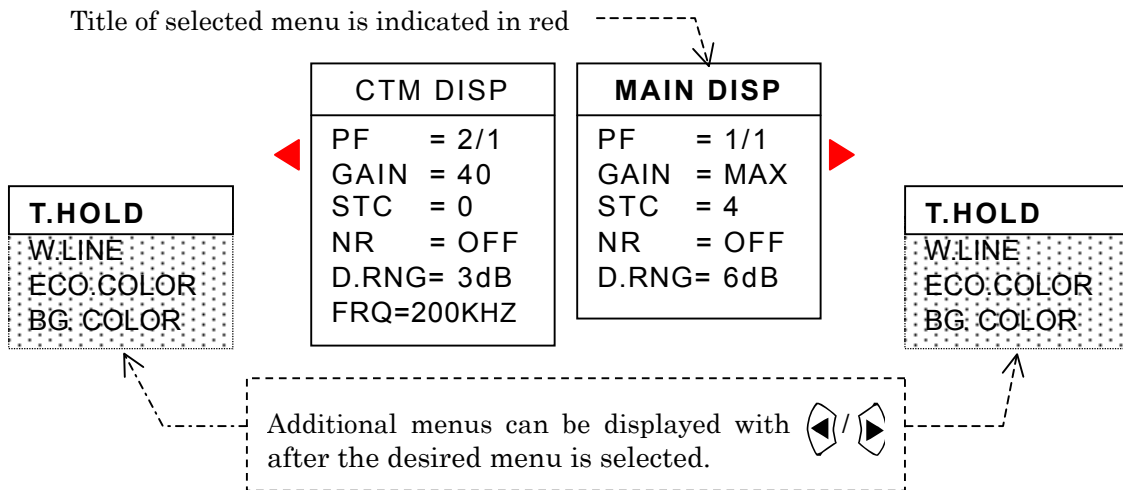

\* The advanced setting mode can be enabled via path: **MENU 7:MODE 2:ADVANCED MODE 2:ON**, and the split-screen presentation can then be activated by holding down **AUTO** for two seconds or longer.

To change the parameters across the desired display, execute the following steps:

- (1) Press / to select either the **MAIN DISP** or the **CTM DISP** menu. The title of the selected menu is indicated in red.
- (2) Press / to select the parameter you wish to set. The selected parameter is indicated on a bright blue background, while the rest of the parameters are indicated on a subdued blue background.
- (3) Press . The selected parameter is framed in red.
- (4) Press / to select the desired setting level, and then press **FUNC** to turn off the menus.

Pressing / again after step (1) above opens an additional control menu hidden behind the selected menu. To set parameters on the additional control menu, refer to the instructions given below Figure 4-11 on the preceding page.

This key acts as numeric key “8” when entering a user password.

(continued on next page)

#### 4. Keypad Functions *(continued – 14/15)*

Record/Playback Key 

Storing Current Echogram





Pressing this key opens an echogram storage mode selection menu, as illustrated below, with the following options selectable with  /  :

Figure 4-14 Storage Mode Selection Menu

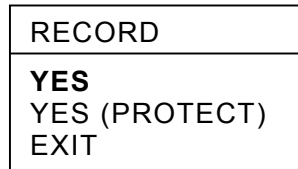

- **YES:** This option stores in memory the current screen page of echogram. After a total of 10 pages are stored, the oldest one will be erased from memory.
- **YES (PROTECT):** This option stores in memory the current page of echogram, and prevents it from being overwritten after the memory becomes full.
- **EXIT:** This option allows you to exit the menu.

To store the current echogram, simply press  after selecting the desired storage mode, “YES” or “YES (PROTECT).”

Recalling Stored Echogram





Holding down this key for two seconds or more opens a recall mode selection menu (**PLAY BACK MODE**), as illustrated below, with the following options selectable with  /  :

Figure 4-15 Recall Mode Selection Menu

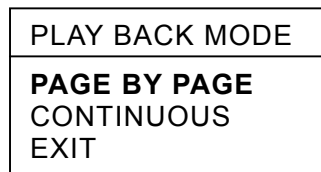

- **PAGE BY PAGE:** This option enables you to recall the stored echogram pages one by one.
- **CONTINUOUS:** This option enables you to recall the stored echogram seamlessly.
- **EXIT:** This option allows you to exit the menu.

To recall the stored echogram pages, simply press  /  after selecting the desired recall mode (**PAGE BY PAGE** or **CONTINUOUS**).

This key acts as numeric key “9” when entering a user password.

*(continued on next page)*

#### 4. Keypad Functions *(continued – 15/15)*



Gain Control Key 

Manual Mode of Operation

Pressing this key opens a gain control window, showing the current receiver gain level as in the example below.

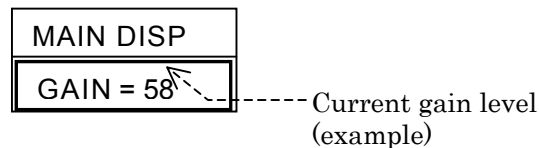
Figure 4-16 Gain Control Window in Manual Mode





The gain level can then be changed by pressing  / .

Automatic Mode of Operation\*

Pressing this key opens a gain control window, showing the current receiver gain level fixed at its maximum level as shown below.

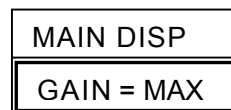
Figure 4-17 Gain Control Window in Automatic Mode



\* *Automatic mode of operation can be activated by holding down  for 2 seconds or longer. See paragraph for details.*

This key acts as numeric key “0” when entering a user password.

Screen Brightness Key 

Pressing this key adjusts the screen brightness level in 9 steps to suit the ambient lighting condition. When the maximum level is reached, further keypress will set the brightness to its lowest level.

Power Key 

Lightly pressing this key turns the equipment on. To turn it off, press and hold down this key for two seconds or longer until two slow beeps are heard, followed by two quick beeps. This delayed action prevents accidental power-off of the equipment.

## 5. Summary Operating Procedure

### 5.1. Basic Operating Procedure

#### 5.1.1. Turning Equipment on/off

To turn the equipment on, lightly press .

To turn the equipment off, press and hold down  for a few seconds until the screen goes black.

*NOTE: This delay in key actuation is intentional to prevent accidental power-off.*

#### 5.1.2. Adjusting Screen Brightness Level



Repeatedly press  until the desired level is reached.

#### 5.1.3. Turning Keypad Backlighting on/off

Press  to open the main menu (MENU).

Select menu option “5: DIMMER” by pressing \*.



Select option:

- “2: ON” by pressing \* , or
- “1: OFF” by pressing \* .

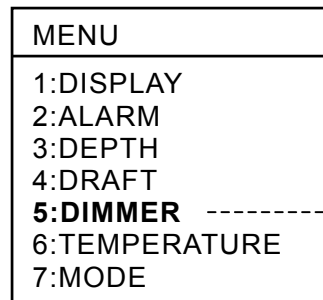
Press  to close the menu.



\* *NOTE: These keys function as numeric keys when a menu is displayed:*

-  : Enters numeral “5.”
-  : Enters numeral “2.”
-  : Enters numeral “1.”

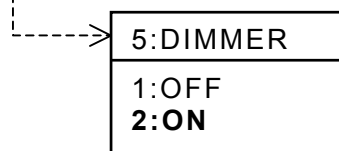

#### 5.1.4. Selecting Control Modes

To activate automatic mode of operation (**FULL AUTO**), lightly press **AUTO** .

To activate manual mode of operation (**MANUAL**), lightly press **AUTO** again.

- **FULL AUTO**: Automatically selects basic ranges and adjusts receiver gain and STC levels so that the bottom echo shows in red at all times either in the lower half screen area or at an appropriate position within the screen.
- **MANUAL**: Allows manual selection of basic ranges, receiver gain and STC levels.

The current control mode is indicated in the upper right corner, as in the examples below.

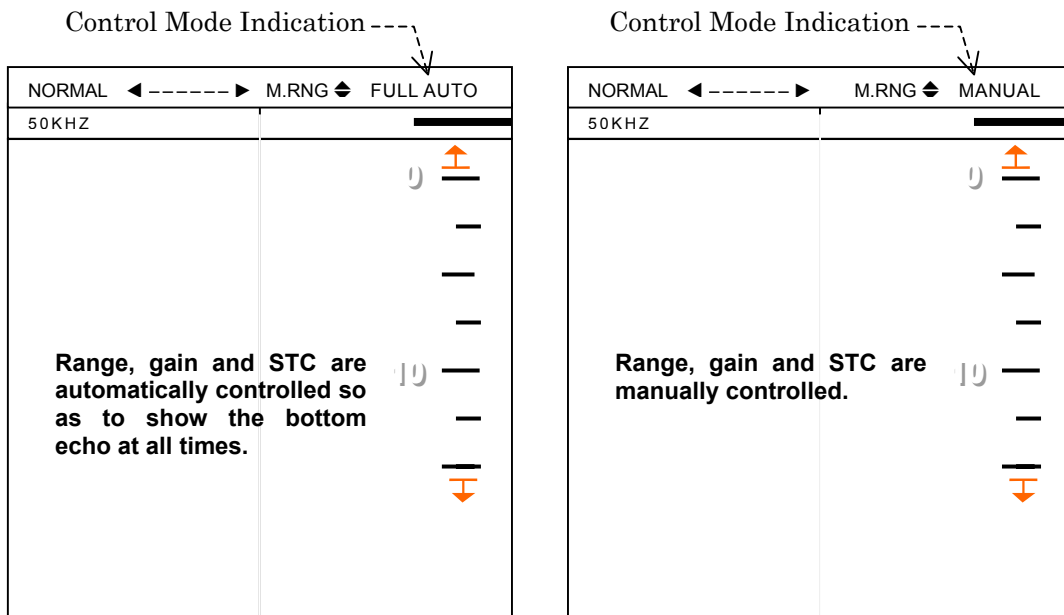

#### 5.1.5. Selecting Display Modes

Press **MODE** repeatedly to select the following display modes in sequence:

- Single frequency full-screen display
- Single frequency split-screen display with pelagic expansion (zooming)
- Single frequency split-screen display with bottom-locked expansion
- Dual frequency split-screen display

An example screen of each display mode is illustrated on next page.

*(continued on next page)*

5.1.5. **Selecting Display Mode** (*continued – 2/2*)

Illustrated below are examples of the four display modes selectable by pressing MODE.

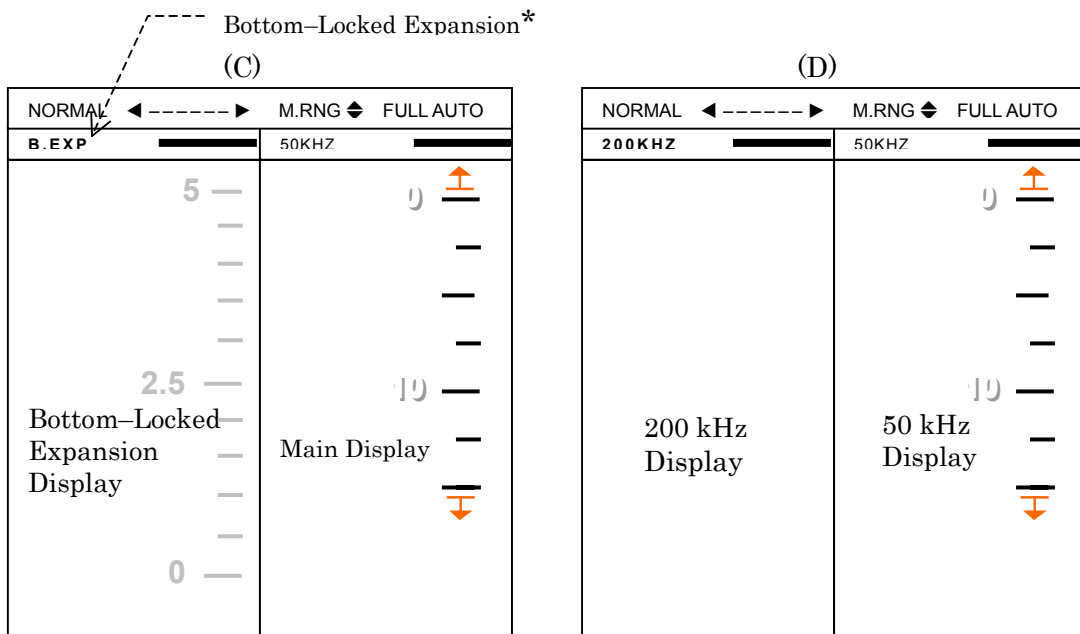
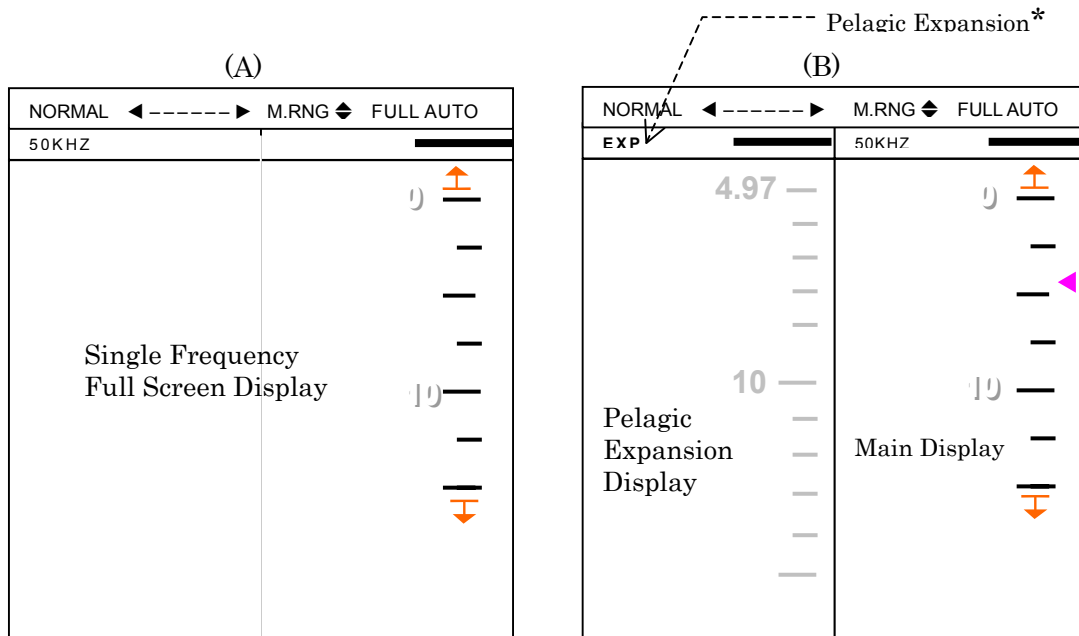

\* *Display Mode Indications:*

- **EXP** = Pelagic expansion (mid water expansion)
- **B. EXP** = Bottom-locked expansion

### 5.1.6. Selecting Operating Frequencies

Press **ENT** to:

- change the operating (transducer) frequency (from/to 50/200 kHz) during single frequency full-screen operation, or
- switch the 50 kHz screen and 200 kHz screen during dual frequency split-screen operation.

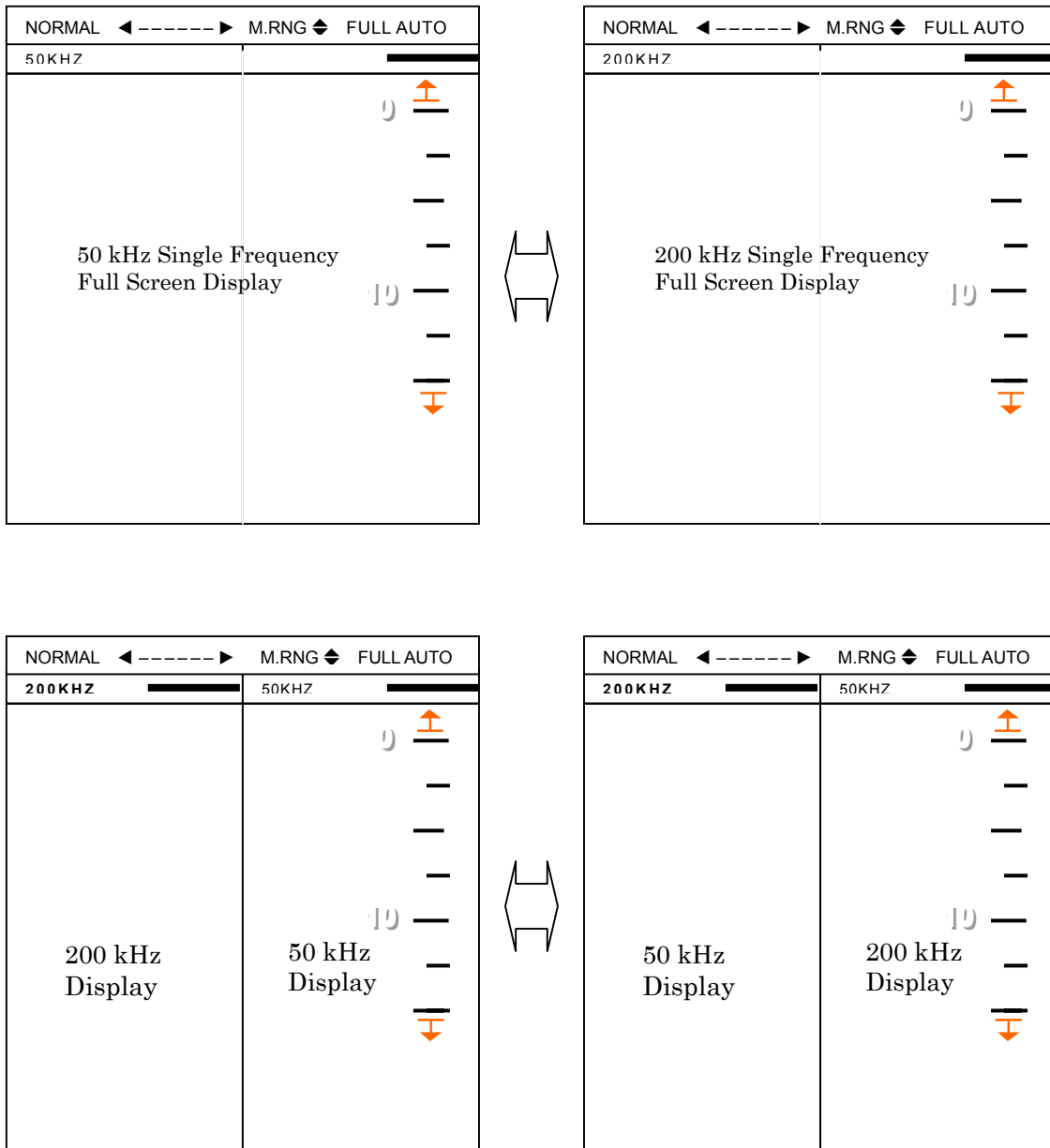



### 5.1.7. Selecting Basic Ranges

The following procedure applies when the equipment is placed in the **MANUAL** control mode (ref. paragraph 5.1.4 above).

#### 5.1.7.1. Selecting Basic Ranges on Single Frequency Full-Screen Display

Press  .

Press:

-  to select greater ranges, or
-  to select smaller ranges.



#### 5.1.7.2. Selecting Basic Ranges on Single Frequency Split-Screen Display

To select basic ranges across the main/normal echogram screen,

Press  once or twice until the scale lines and calibrating numbers become white, with those across the expanded echogram screen showing in gray.

The on-screen control parameter indication should read “**M.RNG** \* ,” as in the example below.

Press:

-  to select greater ranges, or
-  to select smaller ranges.

\***M.RNG** = Main Range

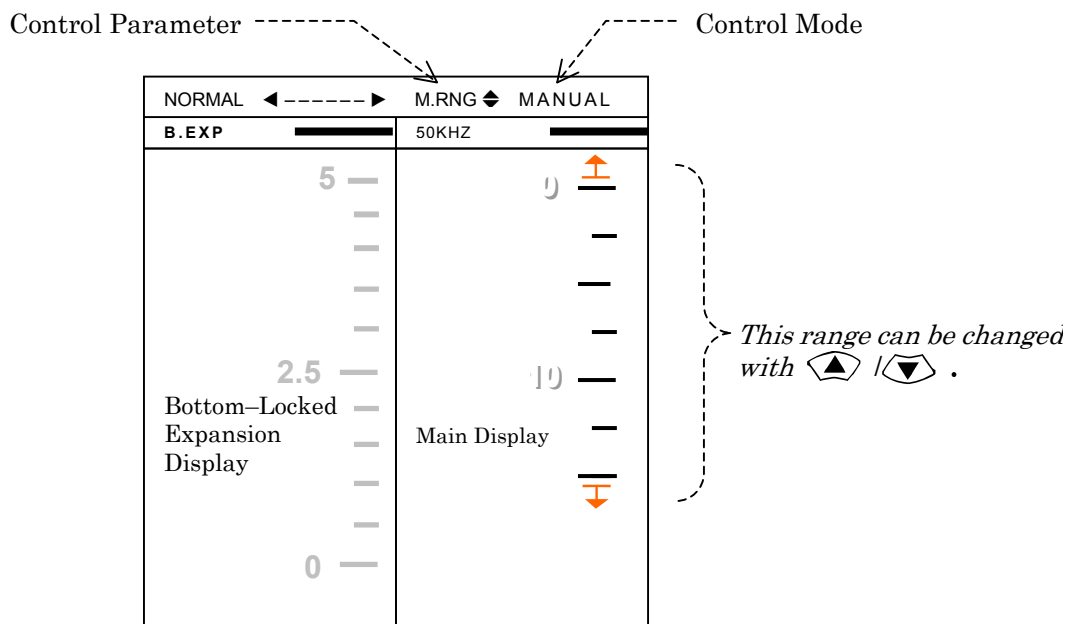

### 5.1.8. Selecting Expansion Ranges



It is assumed that the screen is split in two, showing main/normal echogram across the right half screen and expanded echogram across the left half screen.

Press  twice so that the scale lines and numbers across the main/normal echogram screen become gray (changes from white to gray), with those across the expanded echogram screen showing in white.

The on-screen control parameter indication should read “**SUB.RNG** \* ,” as in the example below.

\* **SUB.RNG** = Sub Range

Press:

-  to select greater ranges, or
-  to select smaller ranges.

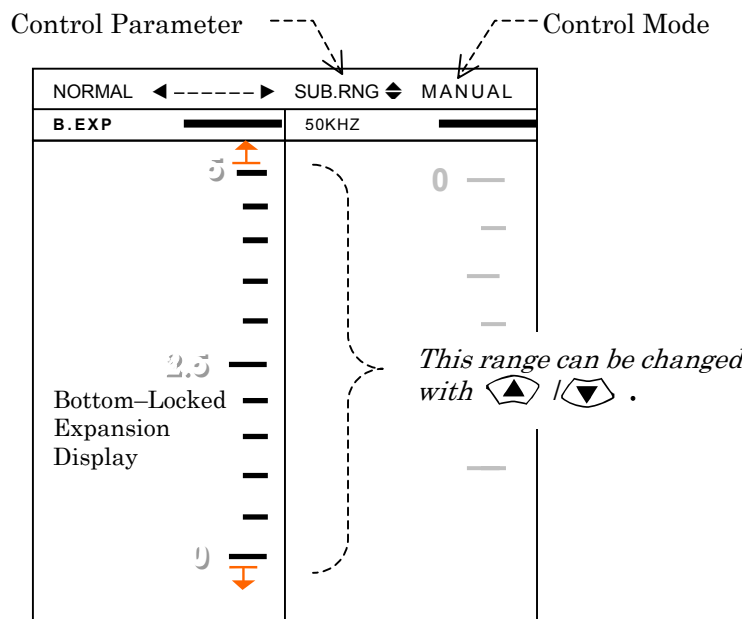

*NOTE: The above example shows the selection of bottom-locked expansion ranges across the left half screen. The same procedure applies when selecting the pelagic expansion ranges.*



### 5.1.9. Shifting Selected Basic Range

The following procedure applies when the equipment is placed in the **MANUAL** control mode (ref. paragraph 5.1.4 above).

#### 5.1.9.1. Shifting Basic Range on Single Frequency Full-Screen Display

Press  .

Press:

-  to shift the selected range downward (toward deepening direction), or
-  to shift the selected range upward (toward shallowing direction).

#### 5.1.9.2. Shifting Basic Range on Single Frequency Split-Screen Display



To shift the selected basic range across the main/normal echogram screen,

Press  once or twice until the scale lines and calibrating numbers become white, with those across the expanded echogram screen showing in gray.

The on-screen control parameter indication should read “**M.SFT\*** ,” as in the example below.

\* **M.SFT** = Main Range Shift

Press:

-  to shift the selected range downward, or
-  to shift the selected range upward.

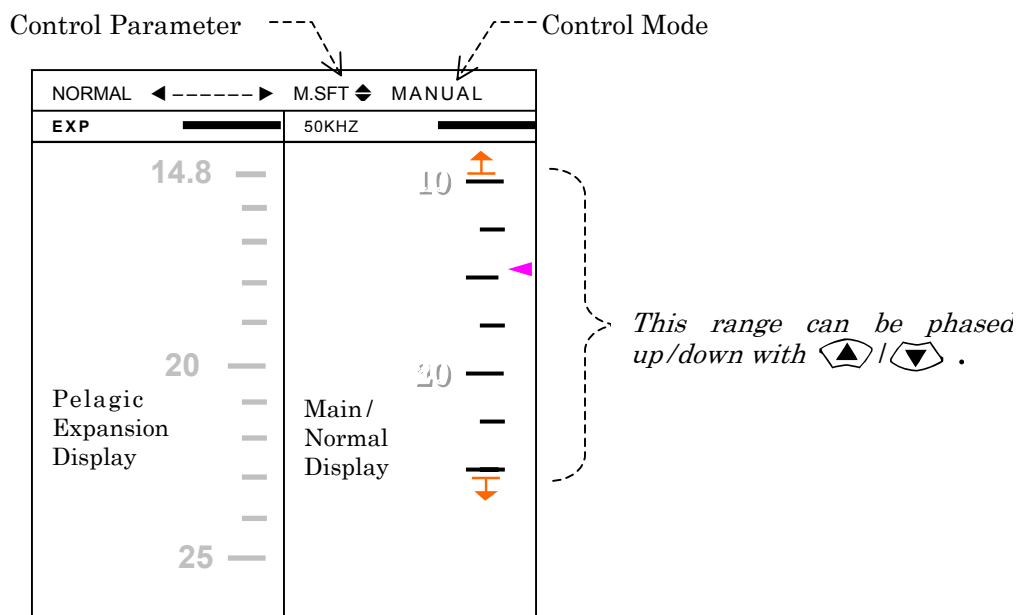

### 5.1.10. Shifting Selected Expansion Range



To shift the selected expansion range across the expanded echogram screen,

Press  once or twice until the scale lines and calibrating numbers become white, with those across the normal echogram screen showing in gray.

The on-screen control parameter indication should read “**SUB.SFT** \* ,” as in the example below.

\* **SUB.SFT** = Sub Range Shift

Press:

-  to shift the selected range downward, or
-  to shift the selected range upward.

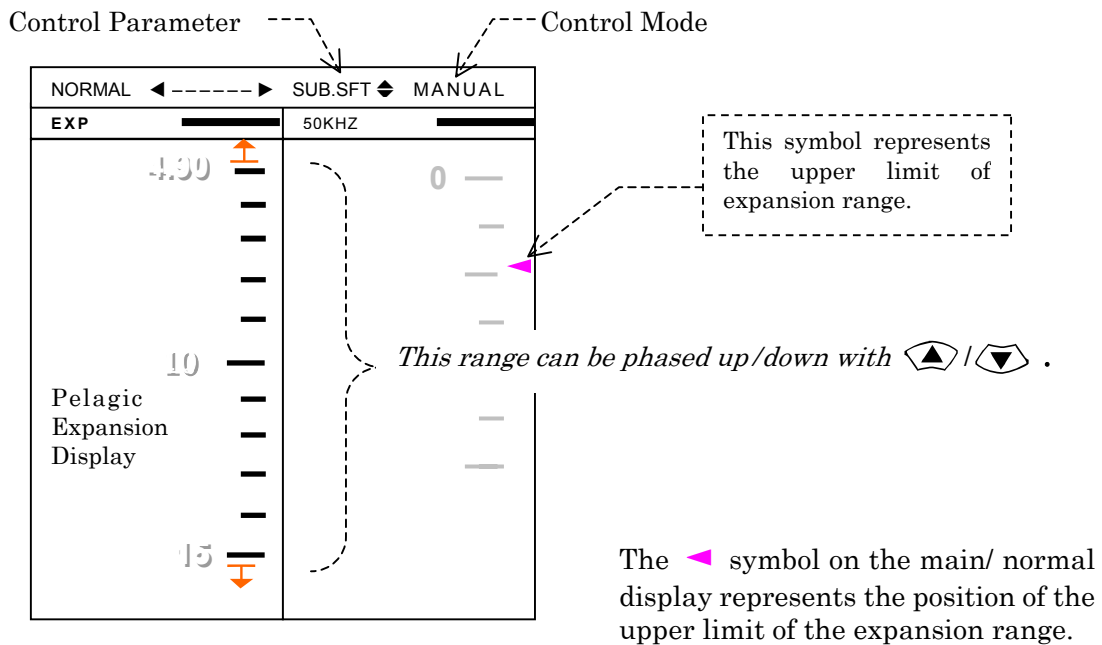



### 5.1.11. Setting Receiver Gain Level

The following procedure applies when the equipment is placed in the **MANUAL** control mode (ref. paragraph 5.1.4 above).

Press .

Press:

-  to increase the gain level, or
-  to decrease the gain level.

## 5.1.12. Selecting Echo Dynamic Ranges

### 5.1.12.1. Introduction

Echoes are displayed using up to seven different colors depending on their strengths. The colors that are currently used to show echoes are indicated in the form of a color scale at the screen's left edge, with the top color (initially blue) and bottom end colors (initially red) representing the weakest and strongest echoes, respectively. The echo dynamic range refers to how much change in echo strength must occur before an echo can be displayed in adjacent stronger or weaker color.

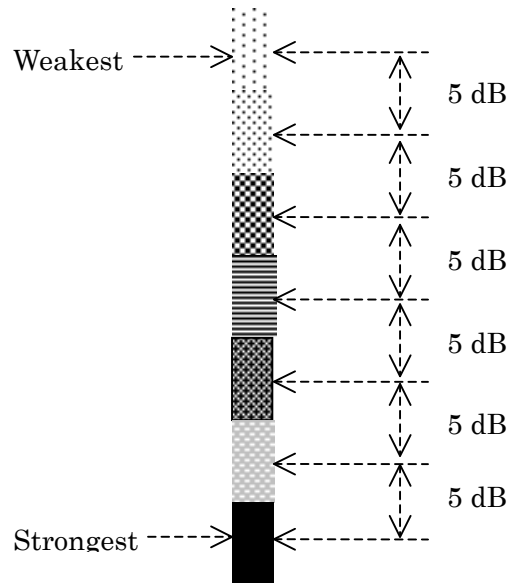

The following selectable dynamic ranges: 3 dB, 4 dB, 5 dB and 6 dB. Selecting a greater dynamic range will require a greater change in strength for an echo to be displayed in a next strong color.



- 3 dB: optional setting, suitable for working over soft grounds where the bottom echo shows in weak colors. This dynamic range will cause otherwise weak echoes to show in strong colors. Successful bottom tracking and digital depth readout requires the bottom echo to be displayed in red or orange (or user-assigned colors). A 3-dB change represents a change of approx. 1.4 times in strength.
- 4 dB: optional setting, a compromise between 3 and 6 dB. A 4 dB change represents a change of approx. 1.6 times in strength.
- 5 dB: initial setting, suitable for operation at mid and greater depths or over hard grounds. If you experience situations where otherwise weak echoes, such as air bubbles and plankton concentrations, show up in stronger colors at normal gain settings, try this range or 6 dB. A 5-dB change represents a change of approx. 1.8 times in strength.
- 6 dB: optional setting. Try this if 5dB setting still produces majority of echoes in strong colors. A 6-dB change represents a change of approx. 2 times in strength.

### 5.1.12.2. Selection Procedure

Press **FUNC** to display the **MAIN DISP** menu.

Select option "**D.RNG = XdB**" by pressing  /  , and press **ENT** .

Press  /  to select the desired dynamic range.

Press **FUNC** again to close the **MAIN DISP** menu.

MAIN DISP	
PF	= 1/1
GAIN	= MAX
STC	= 6
NR	= OFF
<b>5.1.1.1. D.RN</b>	

### 5.1.13. Setting STC Level

#### 5.1.13.1. Introduction



STC (sensitivity–time control) suppresses the receiver gain over a shallow range just below the surface, and gradually restores it to the normal gain level as depth becomes greater. The STC function can be turned on and its level of suppression can be adjusted in 20 steps from level 0 (no STC effect) to level MAX(maximum STC effect). via the following instructions.



The function is used mainly to reduce the receiver gain for strong echoes from air bubbles and other noise-producing particles near the surface, thereby preventing such echoes from disturbing digital reading or automatic bottom-tracking operation.

At its maximum setting (**STC=MAX**), STC will cause the greatest initial gain suppression; under this condition, it should be impossible for weak echoes from shallow depths to be displayed. If you are looking for fish in shallow water, therefore, avoid using too high STC level. In extremely shallow water applications where you find the receiver gain too high even at its minimum level, STC may be used to cause additional gain reduction.

#### 5.1.13.2. Selection Procedure

Press  to display the **MAIN DISP** menu.

Select option “**STC = XX**” by pressing  /  , and press  .



Press  /  to set the desired STC level.



Press  again to close the **MAIN DISP** menu.

<b>MAIN DISP</b>	
PF	= 1/1
GAIN	= MAX
<b>STC</b>	<b>= 4</b>
NR	= OFF
D.RNG	= 5dB

#### 5.1.14. Selecting Noise Reduction (NR) Levels

Press  to display the **MAIN DISP** menu.

Select option “**NR = X**” by pressing  /  , and press  .

Press  /  to select the desired NR level.

The following noise reduction levels are selectable:

- **NR=OFF**: NR function turned off
- **NR=LOW**: Low NR level
- **NR=MID**: Medium NR level
- **NR=HIGH**: High NR level

It is possible that the NR function will erase weak fish echoes. If the purpose is to detect weak echoes, the **MID** or **HIGH** level should be avoided.

Press  again to close the **MAIN DISP** menu.

<b>MAIN DISP</b>	
PF	= 1/1
GAIN	= MAX
STC	= 4
<b>NR</b>	<b>= LOW</b>
D.RNG	= 5dB



### 5.1.15. Selecting Echogram Background Colors

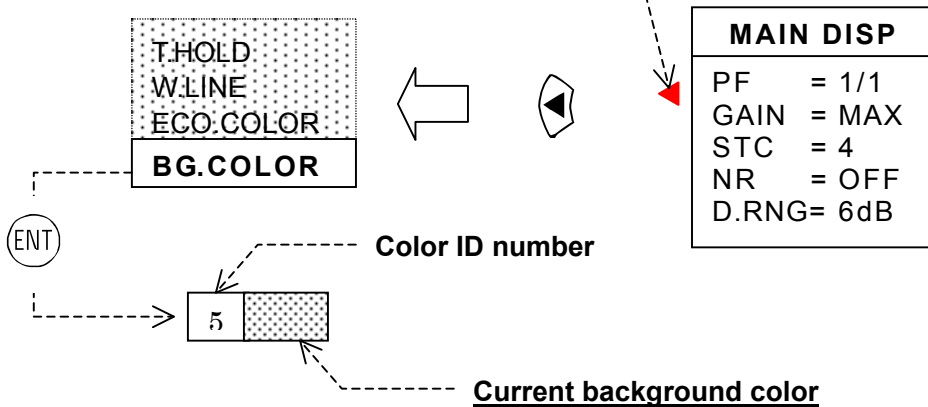

Press **FUNC** to display the **MAIN DISP** menu.

Press  twice to display the additional control menu hidden behind the **MAIN DISP** menu.

*This symbol indicates additional menu is available*



Select option “**BG.COLOR**” with  /  and then press **ENT**. A small window consisting of a number and the current background color will be displayed below the additional menu. A total of 6 different colors are selectable, and the number in the window represents the color currently in use.

Select the desired color by pressing  / .

Press **FUNC** again to return to the echogram screen.

*NOTE: The background colors can also be selected via the following menu-guided path:*

Press **MENU** to display the main menu.

Select option “**1:DISPLAY**” by pressing .

Select option “**4:COLOR**” by pressing **AUTO**.

Select option “**1:BACKGROUND**” by pressing .

Select the desired option by pressing the appropriate numeric key.

Close the menus by pressing **MODE**.

### 5.1.16. Selecting Echo Color Assignments

Echoes are displayed in up to 7 different colors depending on their relative strength levels. The 7 colors are initially assigned seven strength levels as illustrated below.

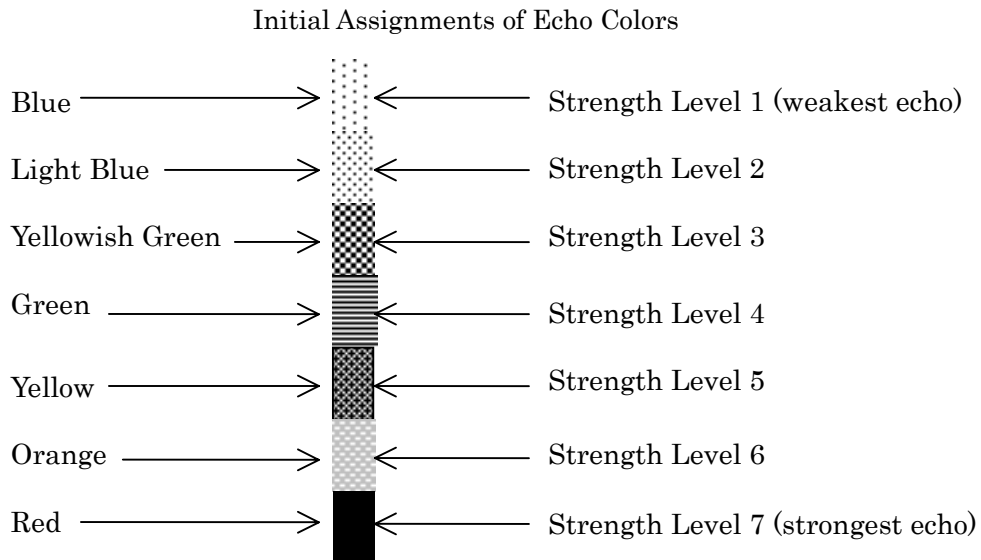

The top-end color (initially blue) represents the weakest echo, and the bottom-end color (initially red), the strongest echo. These initial assignments are based on color group A.

There are a total of seven color groups that can be selected to display echo strength levels. Using the following steps, select the one that best suits your fish finding or bottom characteristics survey applications

Press **FUNC** to display the **MAIN DISP** menu.



Press **◀** twice to display the additional control menu hidden behind the **MAIN DISP** menu.

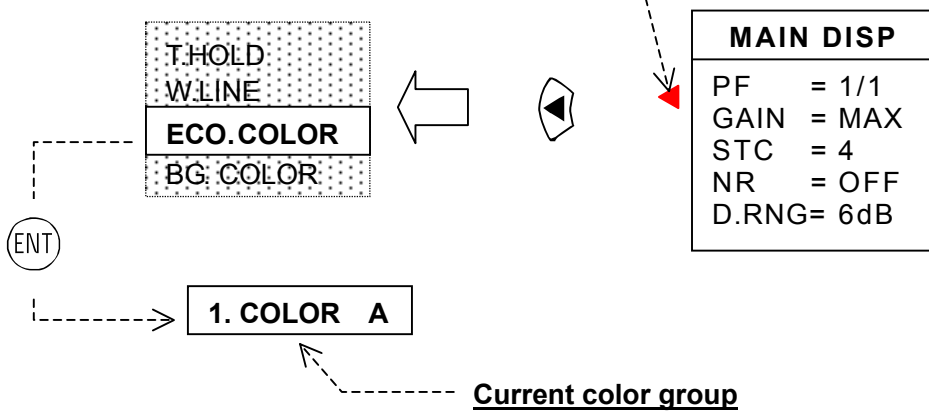

*This symbol indicates additional menu is available*



*(continued on next page)*

### 5.1.16. Selecting Echo Color Assignments *(continued – 2/2)*

Select option “**ECO.COLOR**” with  /  and then press  . A small window showing the current color group will be displayed below the additional menu. A total of 7 different color groups are selectable.

Select the desired color group by pressing  /  .

Press  again to return to the echogram screen.

*NOTE: The color groups can also be selected via the following menu-guided path:*

Press  to display the main menu.

Select option “**1:DISPLAY**” by pressing  .

Select option “**4:COLOR**” by pressing  .



Select option “**2:ECHO COLOR**” by pressing  .

Select the desired option by pressing the appropriate numeric key.

Close the menus by pressing  .

### 5.1.17. Setting White Line Level

White Line (**W.LINE**) is the function of separating the bottom echo from echoes of fish lying on, or close to, the bottom by suppressing only the bottom echo without reducing the receiver gain on the fish echoes. The purpose of the white line function is to facilitate the detection of fish echoes that look like a part of the bottom echo and, therefore, are difficult to detect on the normal echo sounder screen.



Press  to display the **MAIN DISP** menu, and then press  twice to display the additional control menu hidden behind the **MAIN DISP** menu.

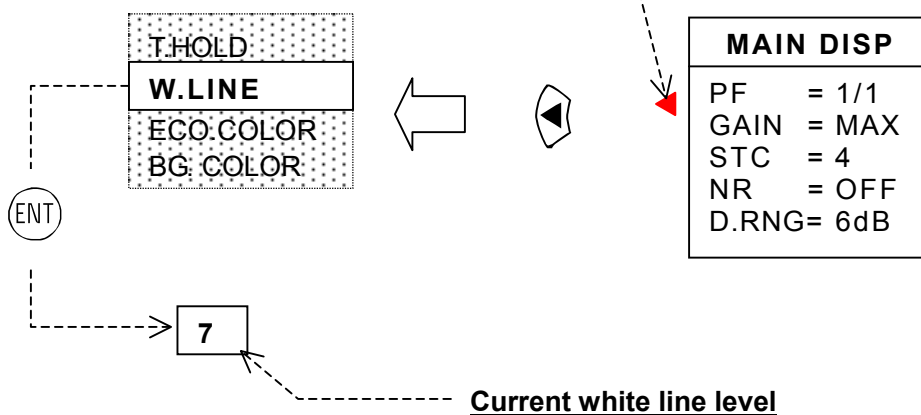

*This symbol indicates additional menu is available*



*(continued on next page)*

### 5.1.17 Setting White Line Level (continued – 2/2)

Select option “**W.LINE**” with  /  and then press  . A small window showing the current white line level will be displayed below the additional menu. The level can be changed in a total of 7 steps.



Set the desired level by pressing  /  .



- Level 7: No bottom echo suppression will occur (initial setting).
- Level 6: The strongest color of the bottom echo will be suppressed.
- Level 5: The strongest and second strongest colors will be suppressed.
- ⋮
- ⋮
- ⋮
- Level 0: All bottom echo colors will be suppressed, leaving only the bottom contour.

Press  again to return to the echogram screen.



### 5.1.18. Setting Echo Threshold Level

Echoes are shown in up to seven different colors depending on their relative strengths. The color sample scale at the left edge on the echogram screen shows the colors that are used to indicate echo strengths, with the bottom-end color (initially red) representing the strongest echo and the top-end color (initially blue), the weakest echo. Echo Threshold (**T.HOLD**) is the function of suppressing the display of weak echo colors, such as surface clutters, allowing only strong color echoes to show up on the screen without decreasing the receiver gain.

Press  to display the **MAIN DISP** menu, and then press  twice to display the additional control menu hidden behind the **MAIN DISP** menu.

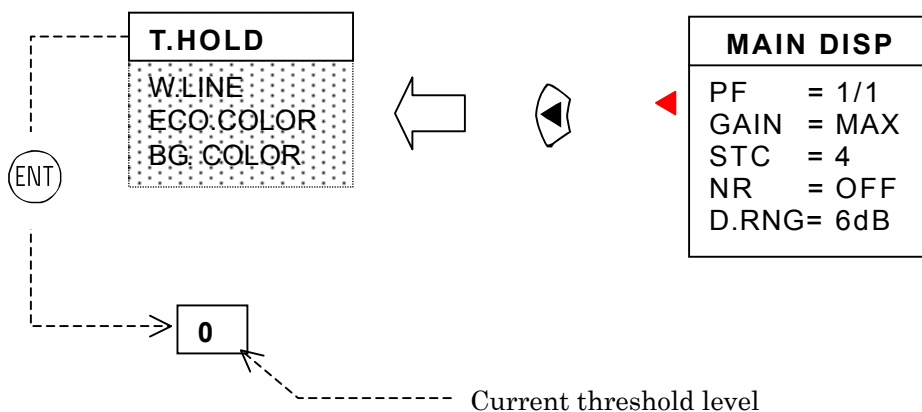
Select option “**T.HOLD**” with  /  and then press  . A small window showing the current threshold level will be displayed below the additional menu. The level can be changed in a total of 7 steps from 0 (no suppression) to 6 (leaving only strongest color echoes on the screen).



Set the desired level by pressing  /  .

Press  again to return to the echogram screen.

### 5.1.19. Selecting Depth Readout Units

Depth readout can be obtained in one of the following units:

- **MT:** meters (initial setting)
- **FT:** feet
- **FM:** fathoms
- **BR:** braccia (Italian/Spanish fathoms)



The depth readout unit is initially set to “**1:MT**” so that the equipment reads depths in meters. To read depths in other unit, proceed as follows:

Press , displaying the main menu.

Select option “**3:DEPTH**” by pressing .

Select option “**1:DEPTH UNIT**” by pressing .

Select the desired unit by pressing the appropriate numeric key. For example:

- To read depths in fathoms, press , selecting option “**3:FM.**”
- To read depths in braccia, press , selecting option “**4:BR.**”

Press  to close the menus.

1:DEPTH UNIT
1:MT
2:FT
3:FM
4:BR

### 5.1.20. Selecting Digital Depth Readout Fonts

The digital depth readout near the lower left corner on the screen is initially indicated in a large font (i.e., in large-sized numbers). If you find this size too big or interfering with close observation of echoes, change it to a small-sized font via the following steps:

Press , displaying the main menu.

Select option “**3:DEPTH**” by pressing .

Select option “**2:FONT SIZE**” by pressing .

Press  to close the menus.

2:FONT SIZE
1:SMALL
2:LARGE

### 5.1.21. Turning on/off A-Scope Display

The A-scope display is initially turned off. It can be turned on via the following steps:

Press , displaying the main menu.

Select option “**1:DISPLAY**” by pressing .

Select option “**1:A-SCOPE**” by pressing  again.

Select option “**2:ON**” by pressing .

Press  to close the menus.

1:A-SCOPE
1:OFF
2:ON



### 5.1.22. Setting Transducer Draft

The transducer draft (distance from waterline to transducer) is initially set to 0, so that the depth readout is referred to the transducer face. To read depth from the waterline, set the draft via the following steps:

Press , displaying the main menu.

Select option “**4:DRAFT**” by pressing .



Set the draft by repeatedly pressing  / .

Press  to complete the setting.

Press  to close the menus.

#### < WARNING >

**WITH A TRANSDUCER DRAFT ENTERED, THE ON-SCREEN DIGITAL READOUT SHOWS THE DEPTH FROM THE WATERLINE AND NOT FROM THE SHIP'S BOTTOM. GREAT CARE SHOULD, THEREFORE, BE TAKEN IN USING DEPTH INFORMATION WHEN NAVIGATING SHALLOW WATER AREAS.**

### 5.1.23. Selecting Velocity Standard for Freshwater Operation

Depth measurement is initially based on the underwater velocity of 1500 meters/second. This is the standard for depth measurement in salt water. To read depth accurately in inland waterways (e.g. freshwater rivers and lakes), select the appropriate velocity standard (1480 meters/second) via the following steps:

Press , displaying the main menu.

Select option “**3:DEPTH**” by pressing .

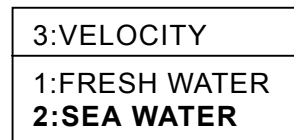

Select option “**3:VELOCITY**” by pressing  again.

Select option “**1:FRESH WATER**” by pressing .

Press  to close the menus.

### 5.1.24. Using Variable Range Marker (VRM)

Press  to turn the VRM on. Press it again to turn it off.

Press  /  to move the VRM to the intended target or depth.



Depth to VRM -----> Readout unit; **MT** = meters

*NOTE: Pressing  with the VRM on sets the alarm depth at its position and at the same time enables the depth alarm function. See paragraph 5.1.26 for details.*

### 5.1.25. Selecting Temperature Readout Units

Water temperature is indicated in the form of “**TEMP XXX°C**” at the screen’s bottom edge just below the digital depth readout when an optional temperature sensor is plugged into the 4-pin rear panel connector. The temperature readout is initially in degrees Celsius (°C). To read temperature in degrees Fahrenheit (°F), execute the following keystrokes:

Press  , displaying the main menu.

Select option “**6:TEMPERATURE**” by pressing .

Select option “**2:°F**” by pressing .

Press  to close the menus.

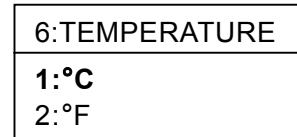

### 5.1.26. Making Depth Alarm Settings

#### 5.1.26.1. Selecting Depth Alarm Modes

Press  , displaying the main menu.

Select option “**2:ALARM**” by pressing .

Select option “**1:DEPTH ALARM**” by pressing .

Select the desired alarm mode by pressing the appropriate numeric key.

- **1:SHALLOW**: Alarms against decreasing depth.
- **2:DEEP**: Alarms against increasing depth.

*NOTE: Option “1:SHALLOW” is initially selected.*

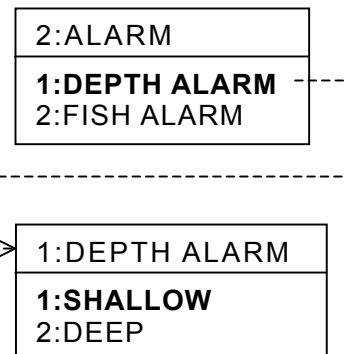

#### 5.1.26.2. Setting Alarm Depth

It is assumed that the normal echogram screen is currently showing.

Press  to turn the VRM (variable range marker) on.

Using  /  , move the VRM to the intended alarm depth.

Press  to set the alarm depth.

The alarm mode and alarm depth will be indicated at the lower right corner on the screen, as in the example at right.

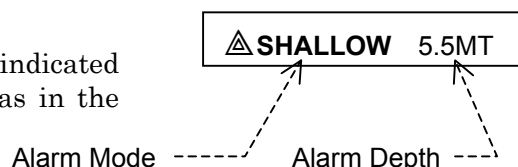

To disable the alarm function, press  again.

### 5.1.27. Making Fish Alarm Settings

The fish alarm will alert you audibly and visually when a fish school is located. To utilize this function, you must activate it, and set the echo size and level that trigger the alarm, via the following procedure.

#### 5.1.27.1. Activating Fish Alarm

The fish alarm can be turned on via the following steps:

Press , displaying the main menu.

Select option “**2:ALARM**” by pressing .

Select option “**2:FISH ALARM**” by pressing  again.

Select option “**2:ON**” by pressing  again.

Proceed to next step to set the alarm-triggering size, or

press  to exit the menu system.

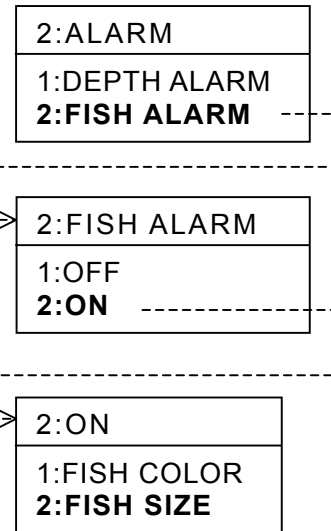

#### 5.1.27.2. Setting Minimum Echo Size for Triggering Fish Alarm

To set the relative fish school size that triggers the alarm, execute the following keystrokes:

Select option “**2:FISH SIZE**” by pressing .

Three relative fish school sizes are selectable. Option “**2:MEDIUM**” is initially selected. At this setting, fish schools of medium or larger size will trigger the fish alarm, and small fish schools will be ignored.



Press the appropriate numeric key to specify the size. For example, to set the size level to “**3:LARGE**,” press .

Press  to return to the previous menu to set the minimum echo strength level that triggers the alarm, or

press  to exit the menu system.

### 5.1.27.3. Setting Minimum Strength Level for Triggering Fish Alarm



To set the minimum echo strength level that triggers the alarm, execute the following keystrokes:

Select option “**1:FISH COLOR**” by pressing .

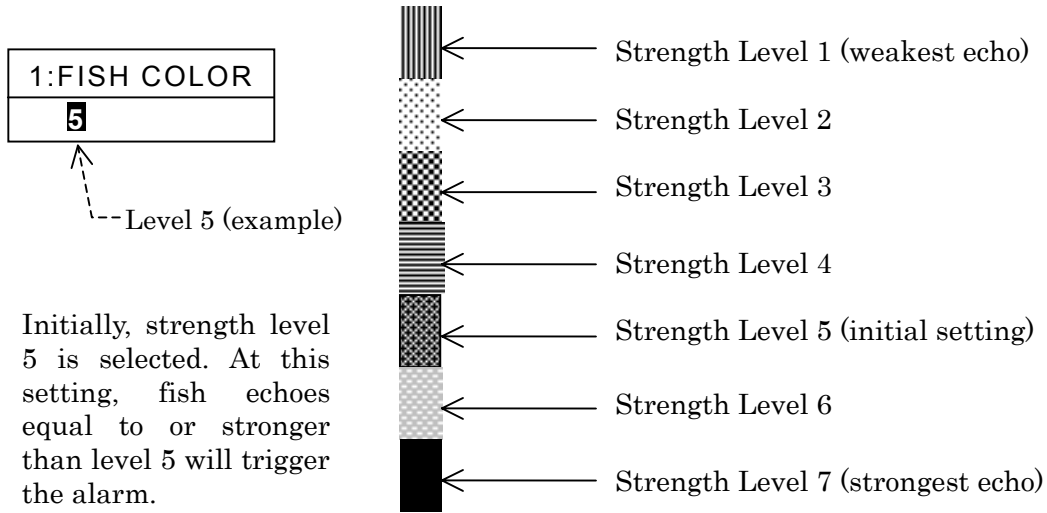

The strength level is indicated in a number from 1 to 7 that represents a particular echo color, as illustrated below.



Initially, strength level 5 is selected. At this setting, fish echoes equal to or stronger than level 5 will trigger the alarm.

Using  / , set the desired strength level.



Press  to complete the setting.

Press  to return to the previous menu or  to exit the menu system.

### 5.1.28. Selecting Echogram Feed Rates

The echogram feed rate can be changed in a total of 7 steps via the following procedure.

Press , displaying the feed rate control window.

Using  / , select the desired feed rate.

<b>MAIN DISP</b>	
<b>PF=</b>	<b>1/1</b>

- **PF= 2/1** (twice normal rate)
- **PF= 1/1** (normal rate)
- **PF= 1/2** (half normal rate)
- . . . . .
- **PF= 1/32** (lowest rate)
- **PF= STOP** (freezes feed, while keeping digital depth reading active)

The window will be automatically turned off in approx. 5 seconds.

### 5.1.29. Selecting Screen Split Modes

The screen is initially split into right half and left half (vertical split) when the dual frequency mode of operation or single frequency expansion mode of operation is activated by pressing **MODE**.

The screen can be split into upper and lower halves (horizontal split) to show high frequency echogram (or single frequency normal echogram) across the upper half area and low frequency echogram (or bottom/pelagic expansion echogram) across the lower half screen via the following steps:

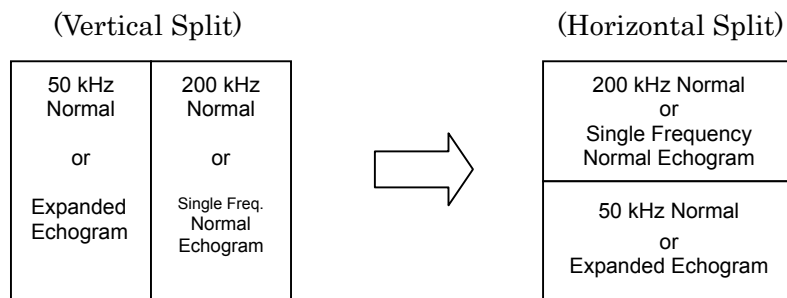

Press **MENU**, displaying the main menu.

Select option “**1:DISPLAY**” by pressing **F1**.

Select option “**2:SPLIT SCREEN**” by pressing **F2** again.

Select option “**2:HORIZONTAL**” by pressing **F2** again.

Press **MODE** to close the menus.

2:SPLIT SCREEN
1:VERTICAL 2:HORIZONTAL

### 5.1.30. Storing Echogram Pages and Recalling Stored Echogram Pages

Up to 10 pages of the current echogram screen can be stored in memory either temporarily or permanently, and, along with position coordinates, date, time, water temperature, when appropriate sensors are plugged in.

#### 5.1.30.1. Storing Current Echogram

Press **REC/PLBK**, turning on the **RECORD** menu.

Using **▲** / **▼**, select the desired option:

- **YES:** Stores current screen temporarily.
- **YES (PROTECT):** Stores current screen permanently, protecting it from being overwritten.
- **EXIT:** Turns menu off, canceling storage.

Press **ENT** to store the echogram.



RECORD
YES YES (PROTECT) EXIT

### 5.1.30.2. Recalling Stored Echogram

The stored echogram pages can be recalled onto the screen via the following steps:

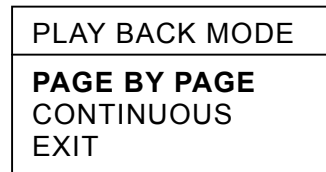
Press and hold down  for two seconds or more to turn on the **PLAY BACK MODE** menu.



Using  / , select the desired option:

- **PAGE BY PAGE:** This option enables you to recall the stored echogram pages one by one.
- **CONTINUOUS:** This option enables you to recall the stored echogram seamlessly.
- **EXIT:** This option allows you to exit the menu.

Press .

You can now review the stored echogram pages, simply press  /  after selecting the desired recall mode (**PAGE BY PAGE** or **CONTINUOUS**).

### 5.1.30.3. Returning to Normal Echogram Screen

To return to the current echogram screen, press and hold down  again for two seconds or more until the recalled screen is turned off.

## 5.1.31. Entering Man-Overboard (MOB) Point

### 5.1.31.1. Introduction

With an optional GPS sensor plugged in (or with specified GPS-derived data fed from an external GPS receiver), the equipment will display the current position (LAT/LON) coordinates, speed, date and time in the screen's lower part below the digital depth readout. The equipment can also store the current position as a point of special interest or the point where a man-overboard (MOB) accident or a similar trouble has just taken place, and can provide steering information that helps you navigate back to that site.

The following procedure assumes that the equipment is currently receiving appropriate GPS-derived data from either an external GPS sensor or a GPS receiver product like a track plotter or other navigational aid.

### 5.1.31.2. MOB Entry Procedure

Press and hold down  for two seconds or more until a short beep is heard. The present position will then be stored in memory. Observe < **WARNINGS** > below, taking care not to overwrite it or turn the equipment off.

#### < WARNINGS >



1. **DO NOT HOLD DOWN THE KEY AGAIN ONCE THE EQUIPMENT BEEPED, OR THE MOB DATA WILL BE OVERWRITTEN.**
2. **DO NOT SWITCH THE EQUIPMENT OFF, OR THE MOB DATA WILL BE LOST.**

### 5.1.31.3. Navigating to MOB

Once the MOB was stored via the preceding procedure, you can display:

- numerically the distance from the present position,
- the time required to go (TTG) to the MOB at the present speed, and
- graphically the bearing to the MOB relative to the ship's current heading

in the screen's lower part via the following steps:

Press  to turn the main menu on, and select option "1:DISPLAY" by pressing  .  
 Press  , selecting option "3:GPS DATA." This will turn on various GPS-derived and MOB-related data like an example illustrated below.

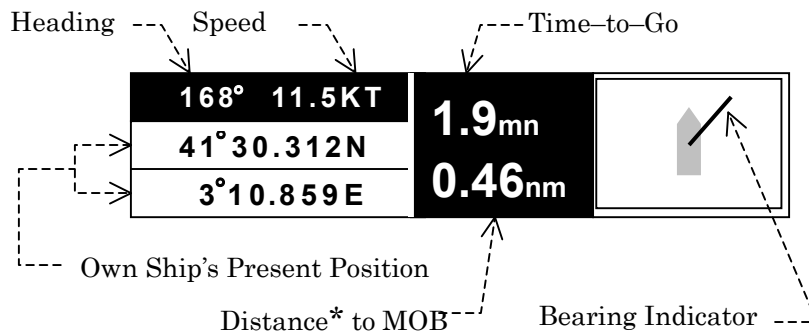

\*Distance less than 0.02 nautical miles will be indicated in meters (MT).

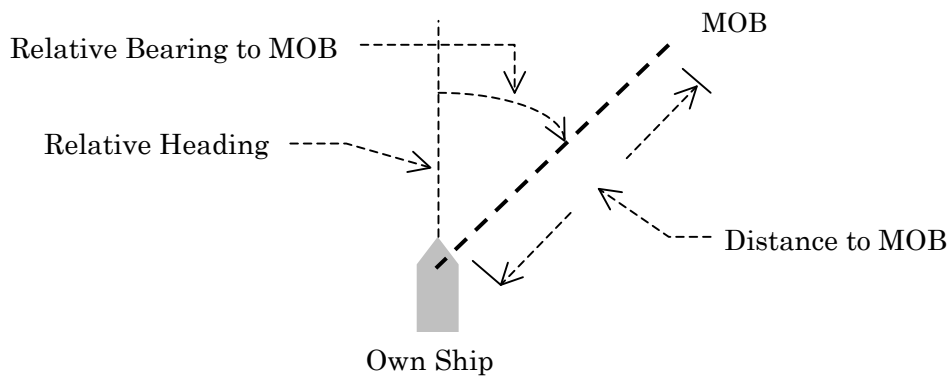



To navigate to the MOB position via the shortest path, steer the ship so that the relative bearing indicator points directly ahead on the ship-shaped symbol, as shown at right.



### 5.1.32. Selecting Types of Navigational Data To Be Displayed

The display of data, such as the current LAT/LON position, speed, heading, date and time, is initially turned off. Those data can be turned on and indicated selectively in a large character size at the lower edge of the screen via the following steps:

Press  to turn the main menu on, and select option “**1:DISPLAY**” by pressing  .  
 Press , selecting option “**3:GPS DATA.**” All data will then be displayed after this step.

Using the appropriate numeric key, select the type of data that you wish to display in a large character size.

- **OFF:** Data display turned off (default)
- **ON(POSITION):** Current LAT/LON coordinates
- **ON(SPEED):** Current speed over ground (SOG)
- **ON(MOB):** Distance & bearing to MOB\*
- **ON(DATE/TIME):** Date and time\*\*

<b>3:GPS DATA</b>	
1:	OFF
2:	<b>ON(POSITION)</b>
3:	<b>ON(SPEED)</b>
4:	<b>ON(MOB)</b>
5:	<b>ON(DATE/TIME)</b>

\* See paragraph 5.1.31 for details. \*\* UTC date and time

Data Display with ON(POSITION) Selected – Example

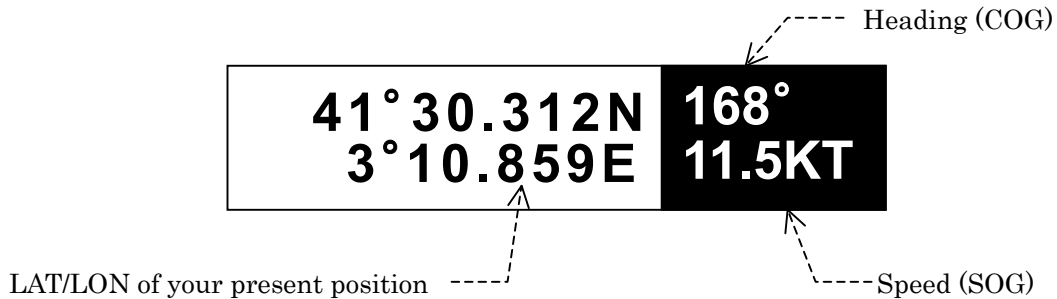

Data Display with ON(DATE/TIME) Selected – Example

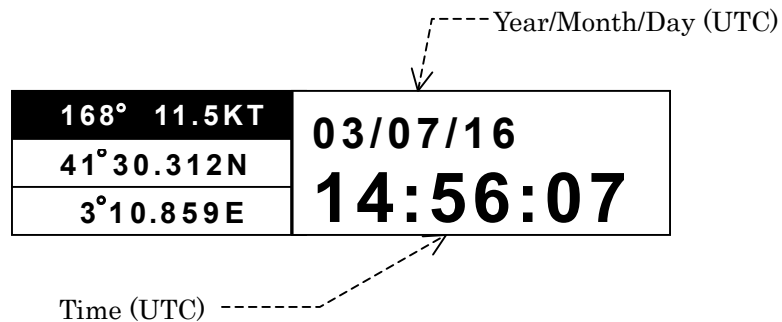

(continued on next page)

5.1.32. **Selecting Types of Navigational Data To Be Displayed** (*continued – 2/2*)

Data Display with ON(SPEED) Selected – Example

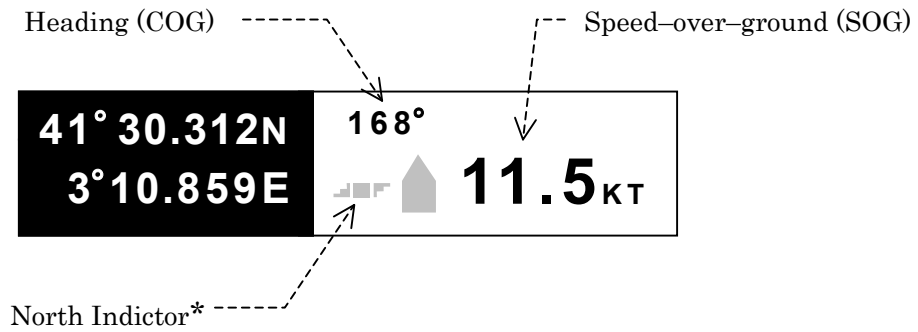

\* North indicator graphically represents the direction of true north relative to the ship's heading, as in the examples below.

Graphic indication of north relative to ship's heading – Examples

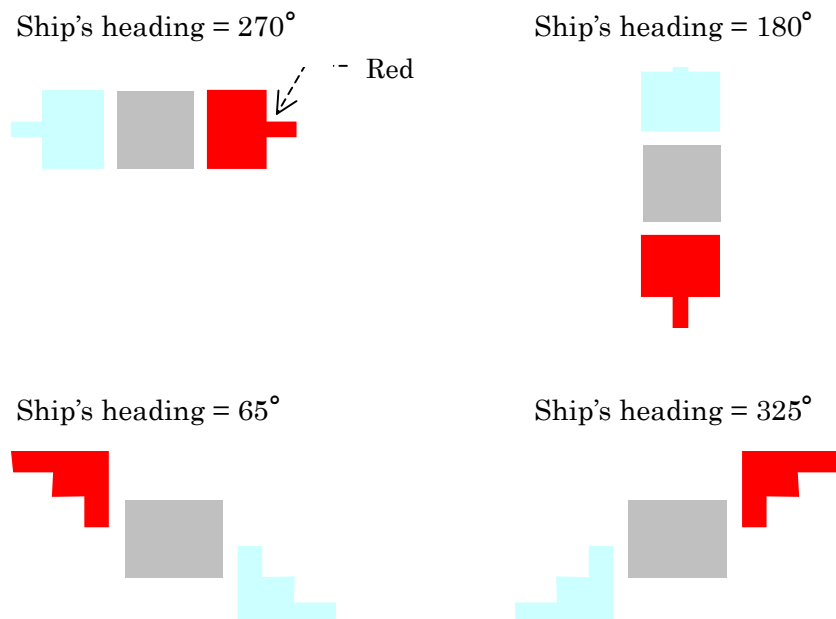

## 5.2. Advanced Operating Procedure

### 5.2.1. Introduction

With the advanced setting mode\* enabled, you can utilize the following features in addition to the basic functions described in paragraph 5.1 and its subparagraphs.

setting the following set of operating parameters separately across split displays (main display and customizable display):

- echogram feed rate (PF)
- receiver gain level (GAIN)
- STC level (STC)
- noise reduction level (NR)
- echo dynamic range (D.RNG)
- frequency (FRQ) (for dual frequency Model V-6202 only)
- echo threshold level (T.HOLD)
- white line level (W.LINE)
- echo color assignments (ECO.COLOR)
- background color (BG.COLOR)



activating the following modes of operation separately across split displays

- manual range selection across customizable display with automatic range selection (AUTO RANGE) or manual range selection (MANUAL) across main display
- manual phasing across customizable display with automatic phasing (AUTO SFT) or manual phasing (MANUAL) across main display
- manual gain (M.GAIN) setting across customizable display with automatic gain setting (AUTO GAIN) or manual gain setting (M.GAIN) across main display

shifting the partition (changing screen split ratio) freely

showing high sounding rate echogram across right-hand display

### 5.2.2. Enabling Advanced Setting Mode

Press  to turn the main menu on, and select option “7:MODE” by pressing .

Press , selecting option “2:ADVANCED MODE.”

Press  again, selecting option “2:ON.”

Press , returning to the echogram screen.

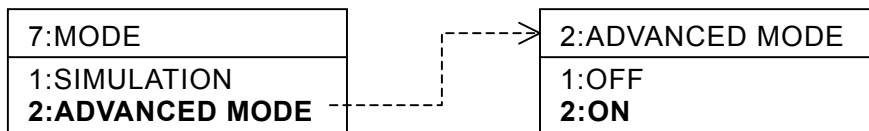

**5.2.3. Activating Advanced Setting Mode**

To activate the advanced setting mode, press and hold down **AUTO** for two seconds or longer. This will split the screen in two (customizable display and main display), as in the example at right.

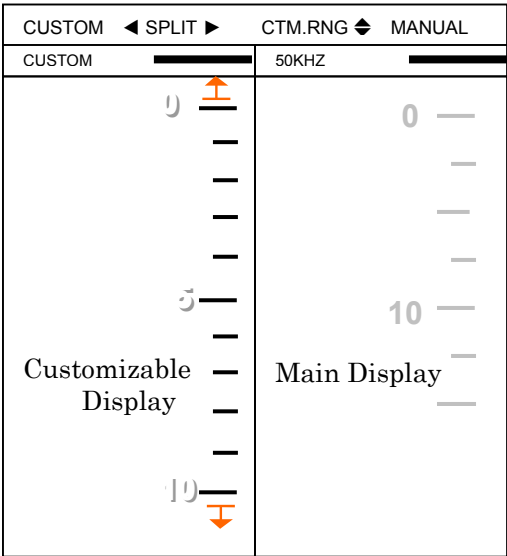

To return to the normal setting mode screen, press and hold down the same key (**AUTO**) again for two seconds or more.

Various operating parameters across each display can then be set via a corresponding control menu that can be turned on by pressing **FUNC** as in the example below.

The **MAIN DISP** menu lists the control parameters that can be set over the main display, while the **CTM DISP** menu lists those that can be set over the customizable display.

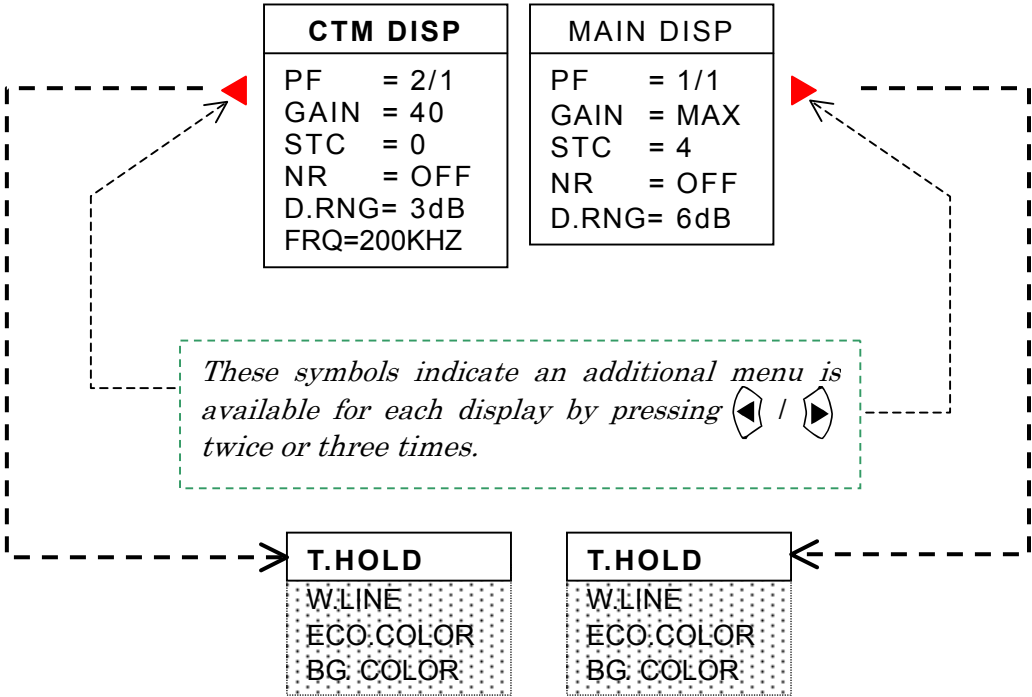

An additional control menu is available for each display by pressing ◀ / ▶ twice or three times, as in the example above.



To turn off all menus at a time, press **FUNC** again.



## 5.2.4. Selecting Echogram Feed Rates

### 5.2.4.1. Selecting Feed Rates on Main Display

It is assumed that both the **MAIN DISP** and **CTM DISP** menus are currently displayed. If they are turned off, press **FUNC** to turn them on.

Press  once so that the **MAIN DISP** menu becomes active (i.e. the menu title "**MAIN DISP**" becomes red).

Using  / , select option "**PF=X/X**," and then press **ENT**. The option will be framed in red.

Repeatedly press  /  to obtain the desired feed rate.

Press **ENT** to complete the setting.

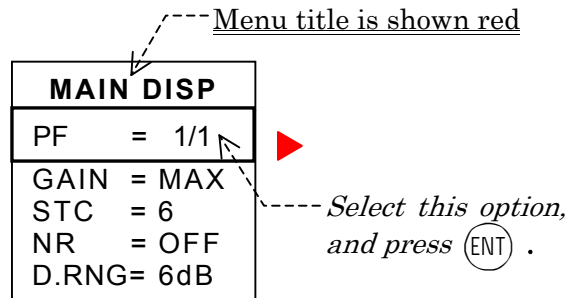

Close the menus by pressing **FUNC**, unless you wish to set other parameters on either display.





### 5.2.4.2. Selecting Feed Rates on Customizable Display

It is assumed that both the **MAIN DISP** and **CTM DISP** menus are currently displayed. If they are turned off, press **FUNC** to turn them on.

Press  once or twice so that the **CTM DISP** menu becomes active (i.e. the menu title "**CTM DISP**" becomes red).

Using  / , select option "**PF=X/X**," and then press **ENT**. The option will be framed in red.

Repeatedly press  /  to obtain the desired feed rate.

Press **ENT** to complete the setting.

Close the menus by pressing **FUNC**, unless you wish to set other parameters on either display.

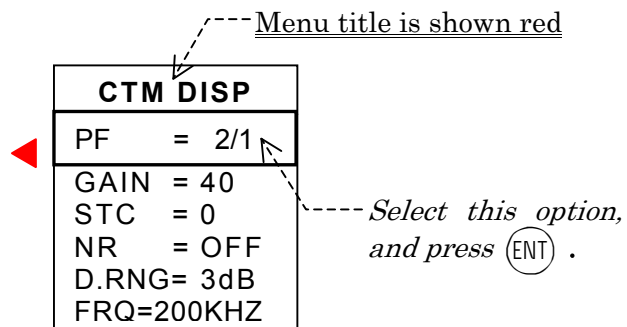



## 5.2.5. Setting Receiver Gain Level



### 5.2.5.1. Manually Setting Receiver Gain on Main Display



It is assumed that both the **MAIN DISP** and **CTM DISP** menus are currently displayed. If they are turned off, press **FUNC** to turn them on again.

Check the control mode indication at the screen's upper right corner. If it is "**MANUAL**" as in the example below, you can set the gain manually on the main display via the following steps.

If the indication reads "**AUTO GAIN**," press and hold down  for two seconds or longer until it changes to "**MANUAL**."

Press  once so that the **MAIN DISP** menu becomes active (i.e. the menu title "**MAIN DISP**" becomes red).

Using  / , select option "**GAIN=XX**," and then press . The option will be framed in red.

Repeatedly press  /  to obtain the desired gain level.

Press  to complete the setting.

Close the menus by pressing **FUNC**, unless you wish to set other parameters on either display.

Control mode indication-----

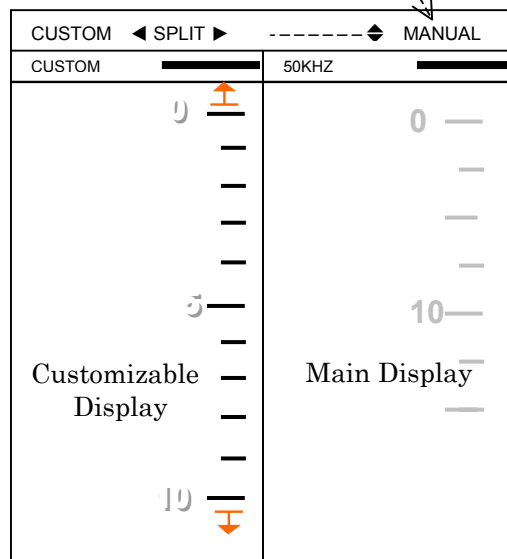

Menu title is shown red

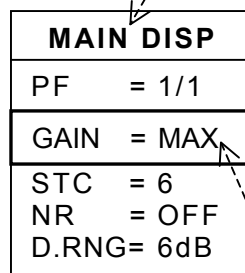

-----Select this option, and press .

*NOTE: The above setting does not affect the gain control setting on the customizable display. To activate the automatic control mode, see the next paragraph for instructions.*

### 5.2.5.2. Automatically Controlling Receiver Gain on Main Display

The receiver gain on the main display can be controlled automatically so as to display the bottom echo in strong colors at all times. Execute the following steps to activate the function.

It is assumed that both the **MAIN DISP** and **CTM DISP** menus are currently displayed. If they are turned off, press **FUNC** to turn them on again.

Press and hold down  for two seconds or longer so that the on-screen control mode indication reads “**AUTO GAIN**” as in the example at right.

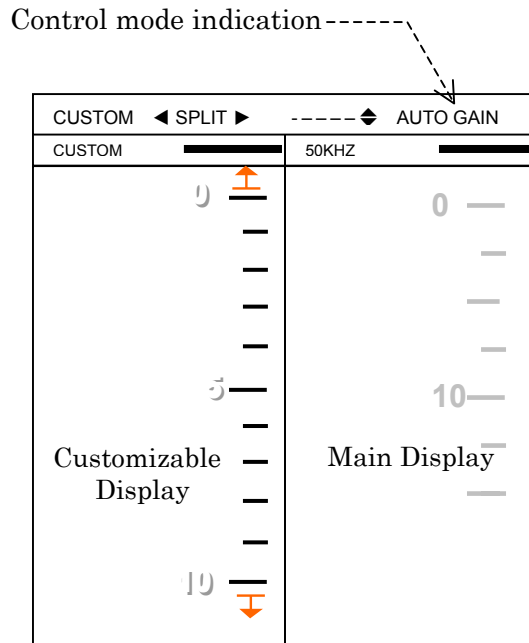

#### Returning to Manual Gain Control Mode



To return to the manual gain control mode, press and hold down  for two seconds or more again so that the mode indication changes to “**MANUAL.**”

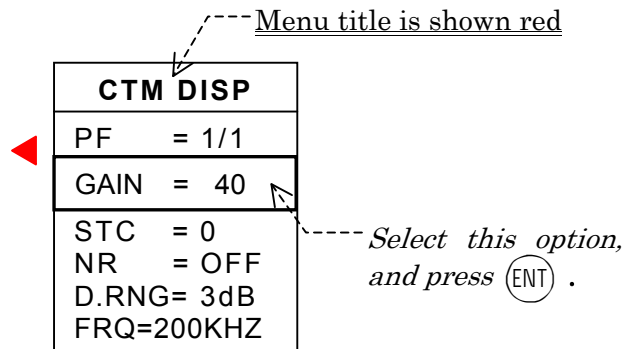

### 5.2.5.3. Setting Receiver Gain on Customizable Display

It is assumed that both the **MAIN DISP** and **CTM DISP** menus are currently displayed. If they are turned off, press **FUNC** to turn them on.

Press  once or twice so that the **CTM DISP** menu becomes active (i.e. the menu title “**CTM DISP**” becomes red).



Using  / , select option “**GAIN =XX,**” and then press **ENT**. The option will be framed in red.

Repeatedly press  /  to obtain the desired gain level, and press **ENT** to complete the setting.

Close the menus by pressing **FUNC**, unless you wish to set other parameters on either display.

*NOTE: The Automatic Gain Control function is not available on the customizable display.*



### 5.2.6. Setting STC Level



The STC (sensitivity–time control) level can be changed from 0 to 20 (**MAX**) in one–unit steps via the following instructions. The greater the level you set, the greater the amount of initial gain suppression becomes, and the longer the range of suppressed gain extends. Level 0 represents no gain suppression.

#### 5.2.6.1. Setting STC on Main Display

It is assumed that both the **MAIN DISP** and **CTM DISP** menus are currently displayed. If they are turned off, press **FUNC** to turn them on.

Press  once so that the **MAIN DISP** menu becomes active (i.e. the menu title “**MAIN DISP**” becomes red).

Using  / , select option “**STC=XX**,” and then press **ENT**. The option will be framed in red.

Repeatedly press  /  to obtain the desired STC level, and then **ENT** to complete the setting.

Menu title is shown red

<b>MAIN DISP</b>	
PF	= 1/1
GAIN	= MAX
STC	= 6
NR	= OFF
D.RNG	= 6dB



*Select this option, and press **ENT**.*



Close the menus by pressing **FUNC**, unless you wish to set other parameters on either display.

#### 5.2.6.2. Setting STC on Customizable Display

It is assumed that both the **MAIN DISP** and **CTM DISP** menus are currently displayed. If they are turned off, press **FUNC** to turn them on.

Press  once or twice so that the **CTM DISP** menu becomes active (i.e. the menu title “**CTM DISP**” becomes red).

Using  / , select option “**STC=XX**,” and then press **ENT**. The option will be framed in red.

Repeatedly press  /  to obtain the desired STC level, and press **ENT** to complete the setting.

Close the menus by pressing **FUNC**, unless you wish to set other parameters on either display.

Menu title is shown red

<b>CTM DISP</b>	
PF	= 1/1
GAIN	= 40
STC	= 0
NR	= OFF
D.RNG	= 3dB
FRQ	= 200KHZ



*Select this option, and press **ENT**.*



## 5.2.7. Setting Noise Reduction (NR) Level

### 5.2.7.1. Setting NR Level on Main Display

It is assumed that both the **MAIN DISP** and **CTM DISP** menus are currently displayed. If they are turned off, press **FUNC** to turn them on.

Press  once so that the **MAIN DISP** menu becomes active (i.e. the menu title "**MAIN DISP**" becomes red).

Using  / , select option "**NR=X**," and then press **ENT**. The option will be framed in red.

Repeatedly press  /  to obtain the desired NR level\*.

\* Avoid **HIGH** level when looking for weak fish or bottom echoes.

Press **ENT** to complete the setting.

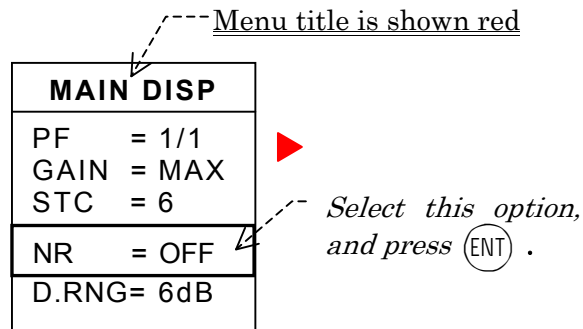

Close the menus by pressing **FUNC**, unless you wish to set other parameters on either display.





### 5.2.7.2. Setting NR Level on Customizable Display

It is assumed that both the **MAIN DISP** and **CTM DISP** menus are currently displayed. If they are turned off, press **FUNC** to turn them on.

Press  once or twice so that the **CTM DISP** menu becomes active (i.e. the menu title "**CTM DISP**" becomes red).

Using  / , select option "**NR=X**," and then press **ENT**. The option will be framed in red.

Repeatedly press  /  to obtain the desired NR level\*.

\* Avoid **HIGH** level when looking for weak fish or bottom echoes.

Press **ENT** to complete the setting.

Close the menus by pressing **FUNC**, unless you wish to set other parameters on either display.

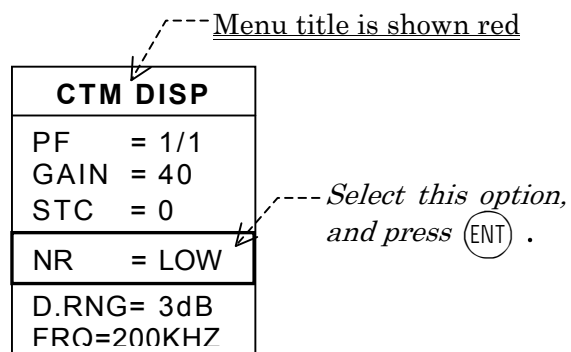





## 5.2.8. Setting Echo Dynamic Range (D.RNG)

### 5.2.8.1. Setting Dynamic Range on Main Display

It is assumed that both the **MAIN DISP** and **CTM DISP** menus are currently displayed. If they are turned off, press **FUNC** to turn them on.

Press  once so that the **MAIN DISP** menu becomes active (i.e. the menu title "**MAIN DISP**" becomes red).

Using  / , select option "**D.RNG=XdB**," and then press **ENT**. The option will be framed in red.

Repeatedly press  /  to obtain the desired dynamic range.

Press **ENT** to complete the setting.

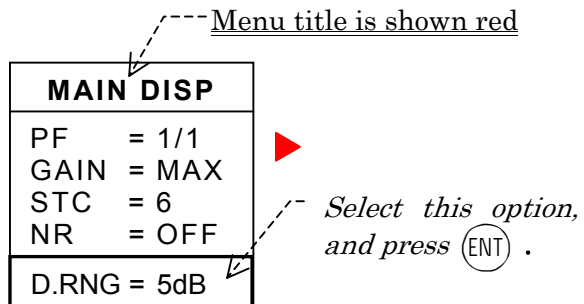

Close the menus by pressing **FUNC**, unless you wish to set other parameters on either display.





### 5.2.8.2. Setting Dynamic Range on Customizable Display

It is assumed that both the **MAIN DISP** and **CTM DISP** menus are currently displayed. If they are turned off, press **FUNC** to turn them on.

Press  once or twice so that the **CTM DISP** menu becomes active (i.e. the menu title "**CTM DISP**" becomes red).

Using  / , select option "**D.RNG=XdB**," and then press **ENT**. The option will be framed in red.

Repeatedly press  /  to obtain the desired dynamic range.

Press **ENT** to complete the setting.

Close the menus by pressing **FUNC**, unless you wish to set other parameters on either display.

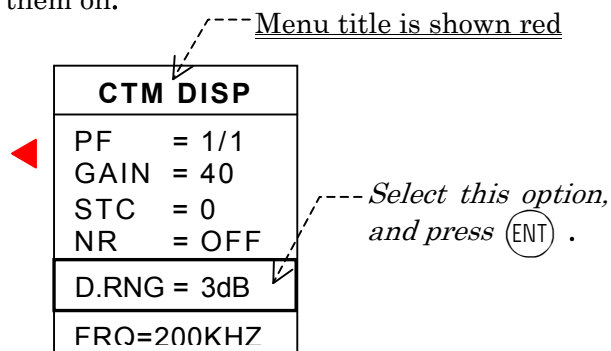

## 5.2.9. Switching Operating Frequencies

### 5.2.9.1. Switching Frequencies on Main Display



It is assumed that both the **MAIN DISP** and **CTM DISP** menus are currently turned off. If they are still on, press **FUNC**.



The operating frequency on the main display can be switched from 50 kHz to 200 kHz or vice versa by simply pressing **ENT**.

### 5.2.9.2. Switching Frequencies on Customizable Display

It is assumed that both the **MAIN DISP** and **CTM DISP** menus are currently displayed. If they are turned off, press **FUNC** to turn them on.

Press  once or twice so that the **CTM DISP** menu becomes active (the menu title "**CTM DISP**" becomes red).

Using  / , select option "**FREQ=XXKHZ**," and then press **ENT**.

Press  or  to set the desired frequency.

Press **ENT** to complete the setting.

Close the menus by pressing **FUNC**, unless you wish to set other parameters on either display.

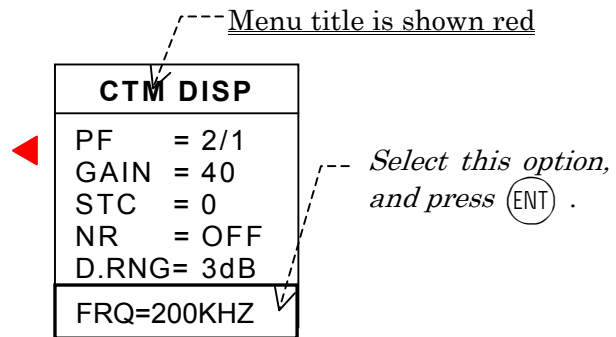





## 5.2.10. Setting Echo Threshold Level

### 5.2.10.1. Setting Echo Threshold Level on Main Display

It is assumed that both the **MAIN DISP** and **CTM DISP** menus are currently displayed. If they are turned off, press **FUNC** to turn them on.

Press  once or twice so that the additional menu shows up over the **MAIN DISP** menu.

Using  / , select option "**T.HOLD**," and then press **ENT**.

Press  /  to set the desired threshold level, and press **ENT** to complete the setting.

The current threshold level is indicated on the right-hand color sample scale.

Press  to return to the **MAIN DISP** menu, unless you wish to set other parameters listed on the additional menu, or **FUNC** to close all menus.

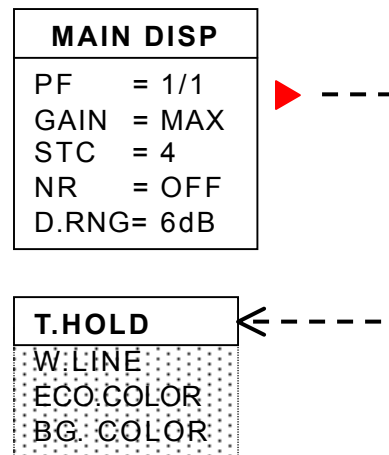

### 5.2.10.2. Setting Echo Threshold Level on Customizable Display

It is assumed that both the **MAIN DISP** and **CTM DISP** menus are currently displayed. If they are turned off, press **FUNC** to turn them on.

Press once or twice so that the additional menu shows up over the **CTM DISP** menu.

Using / , select option “**T.HOLD**,” and then press **ENT**.

Press / to set the desired threshold level.

*The current threshold level is indicated on the left-hand color sample scale.*

Press **ENT** to complete the setting.

Press to return to the **CTM DISP** menu, unless you wish to set other parameters listed on the additional menu, or **FUNC** to close all menus.

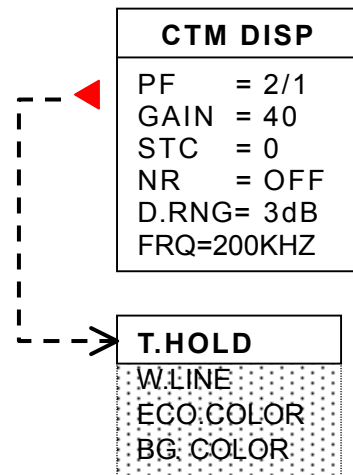

### 5.2.11. Setting White Line Level

#### 5.2.11.1. Setting White Line Level on Main Display

It is assumed that both the **MAIN DISP** and **CTM DISP** menus are currently displayed. If they are turned off, press **FUNC** to turn them on.

Press once or twice so that the additional menu shows up over the **MAIN DISP** menu.

Using / , select option “**W.LINE**,” and then press **ENT**.

Press / to set the desired white line level.

*The current white line level is indicated on the right-hand color sample scale, and also in a numeric value in a small window below the extended menu.*

Press **ENT** to complete the setting.

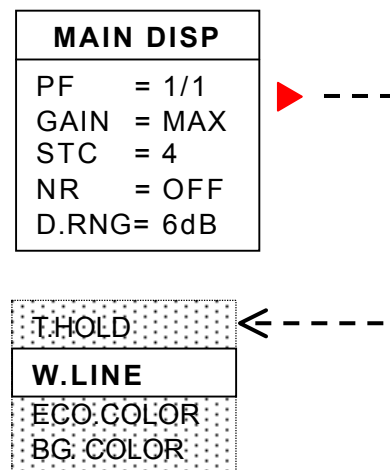

Press to return to the **MAIN DISP** menu, unless you wish to set other parameters listed on the additional menu, or **FUNC** to close all menus.





### 5.2.11.2. Setting White Line Level on Customizable Display

It is assumed that both the **MAIN DISP** and **CTM DISP** menus are currently displayed. If they are turned off, press **FUNC** to turn them on.

Press  once or twice so that the additional menu shows up over the **CTM DISP** menu.

Using  / , select option “**W.LINE**,” and then press **ENT**.

Press  /  to set the desired white line level.

*The current white line level is indicated on the left-hand color sample scale, and also in a numeric value in a small window below the extended menu.*

Press **ENT** to complete the setting.

Press  to return to the **CTM DISP** menu, unless you wish to set other parameters listed on the additional menu, or **FUNC** to close all menus.

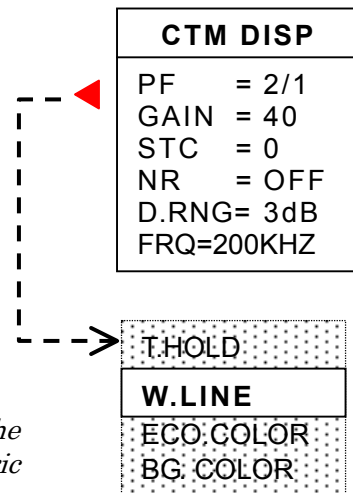





### 5.2.12. Changing Echo Color Assignments

#### 5.2.12.1. Changing Echo Colors on Main Display

It is assumed that both the **MAIN DISP** and **CTM DISP** menus are currently displayed. If they are turned off, press **FUNC** to turn them on.

Press  once or twice so that the additional menu shows up over the **MAIN DISP** menu.

Using  / , select option “**ECO.COLOR**,” and then press **ENT**.

Press  /  to select the desired color assignment pattern.

*The current assignments are shown on the right-hand color sample scale.*

Press **ENT** to complete the setting.

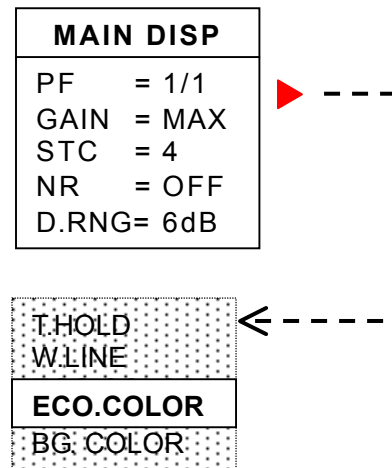

Press  to return to the **MAIN DISP** menu, unless you wish to set other parameters listed on the additional menu, or **FUNC** to close all menus.





### 5.2.12.2. Changing Echo Colors on Customizable Display

It is assumed that both the **MAIN DISP** and **CTM DISP** menus are currently displayed. If they are turned off, press **FUNC** to turn them on.

Press  once or twice so that the additional menu shows up over the **CTM DISP** menu.

Using  / , select option “**ECO.COLOR,**” and then press **ENT**.

Press  /  to select the desired color assignment pattern.

*The current assignments are shown on the left-hand color sample scale.*

Press **ENT** to complete the setting.

Press  to return to the **CTM DISP** menu, unless you wish to set other parameters listed on the additional menu, or **FUNC** to close all menus.

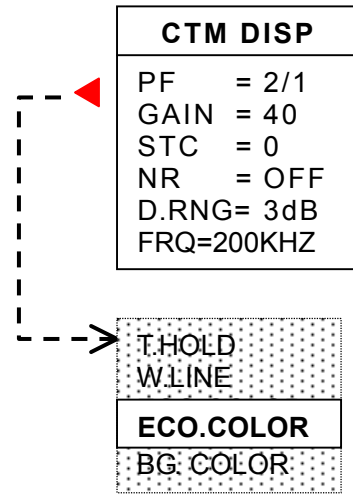





### 5.2.13. Selecting Screen Background Colors

#### 5.2.13.1. Selecting Background Colors on Main Display

It is assumed that both the **MAIN DISP** and **CTM DISP** menus are currently displayed. If they are turned off, press **FUNC** to turn them on.

Press  once or twice so that the additional menu shows up over the **MAIN DISP** menu.

Using  / , select option “**BG.COLOR,**” and then press **ENT**.

Press  /  to select the desired background color.

Press **ENT** to complete the setting.

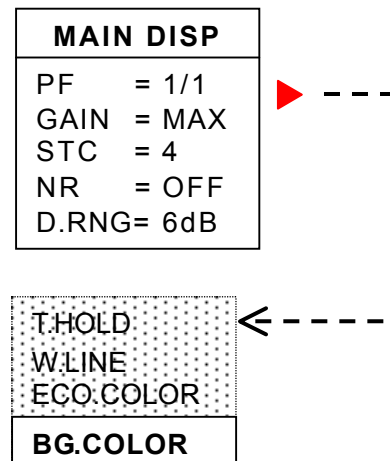

Press  to return to the **MAIN DISP** menu, unless you wish to set other parameters listed on the additional menu, or **FUNC** to close all menus.





### 5.2.13.2. Selecting Background Colors on Customizable Display

It is assumed that both the **MAIN DISP** and **CTM DISP** menus are currently displayed. If they are turned off, press **FUNC** to turn them on.

Press  once or twice so that the additional menu shows up over the **CTM DISP** menu.

Using  / , select option “**BG.COLOR,**” and then press **ENT**.

Press  /  to select the desired background color.

Press **ENT** to complete the setting.

Press  to return to the **CTM DISP** menu, unless you wish to set other parameters listed on the additional menu, or **FUNC** to close all menus.

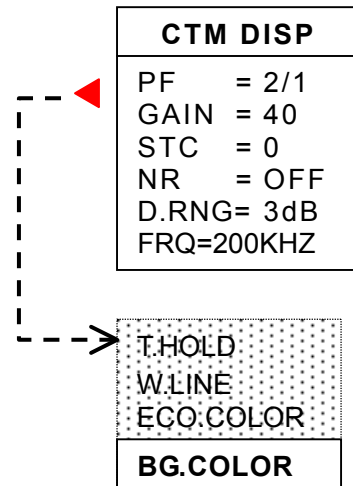

## 5.2.14. Selecting Basic Ranges across Split Display

### 5.2.14.1. Manual Selection of Basic Ranges on Main Display

It is assumed that both the **MAIN DISP** and **CTM DISP** menus are currently turned off. If they are being displayed now, press **FUNC** to turn them off.

Press **4** once or twice so that the control parameter indication just above the frequency readout on the main display reads “**M.RNG \* ◆**” as in the example below.

\* **M.RNG** = Main display range

Under this condition, you will observe:

- that the set of scale lines on the main display is sandwiched between a pair of upward-oriented and downward-oriented arrow-like symbols, and
- that the scale calibration numbers on the customizable display become gray at the same time, indicating that depth range selection on that display is currently disabled.

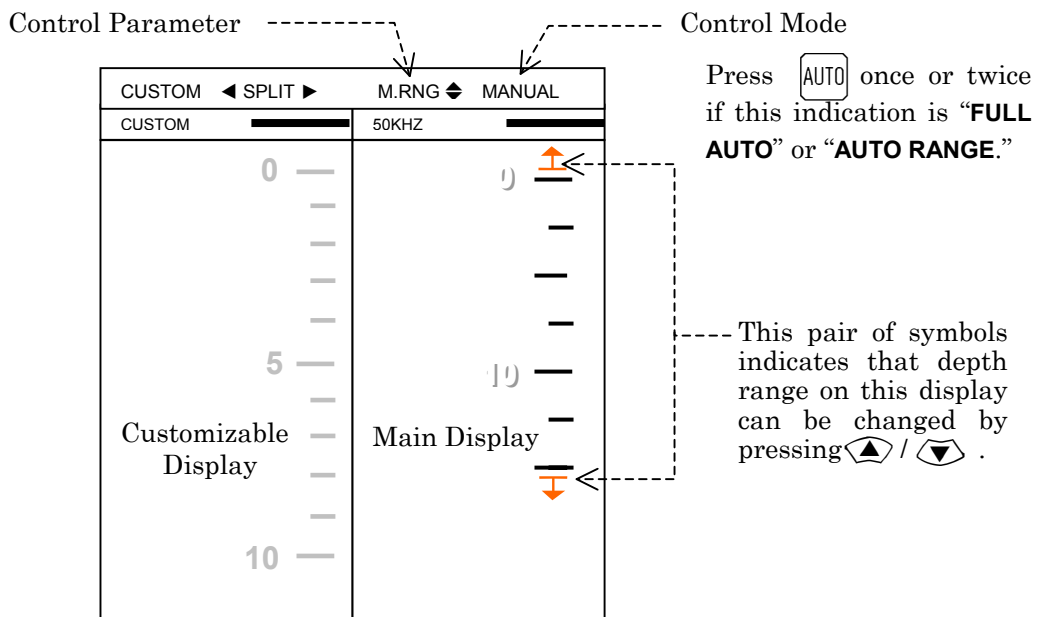

If the control mode indication reads “**FULL AUTO**” or “**AUTO RANGE**,” disable the automatic function by lightly pressing **AUTO** once or twice so that the indication changes to “**MANUAL.**”

Press **▲** / **▼** to select the desired range.

The depth range setting on the customizable display will not be affected.

### 5.2.14.2. Automatic Selection of Basic Ranges on Main Display

It is assumed that both the **MAIN DISP** and **CTM DISP** menus are currently turned off. If they are being displayed now, press **FUNC** to turn them off.

Press **II** once or twice so that the control parameter indication just above the frequency readout on the main display reads “**M.RNG\* ◆**” as in the example below.

\***M.RNG** = Main display range

Control Parameter ----- Control Mode

CUSTOM ◀ SPLIT ▶	M.RNG ◆ AUTO RANGE
CUSTOM	50KHZ
0 —	0 —
—	—
—	—
—	—
5 —	10 —
—	—
Customizable Display	Main Display
—	—
10 —	—

Hold down **II** for 2 secs. or more so that this indication changes from “**MANUAL**” to “**AUTO RANGE**.”

Press and hold down **II** for two seconds or longer so that the control mode indication changes to “**AUTO RANGE**” as in the example at left.

The depth range setting on the customizable display will not be affected.

#### Returning to Manual Range Selection

To return to the manual control mode, hold down **II** for two seconds or longer again so that the control mode indication changes back to “**MANUAL**.”

### 5.2.14.3. Full Automatic Operation on Main Display

It is assumed that both the **MAIN DISP** and **CTM DISP** menus are currently turned off. If they are being displayed now, press **FUNC** to turn them off.

Press **AUTO** once lightly so that the control mode indication changes to “**FULL AUTO**.” The range and receiver gain settings on the main display will then be controlled automatically so as to show the bottom echo in strong colors at all times.

The depth range setting on the customizable display will not be affected.

#### Returning to Manual Range Selection

To return to the manual control mode, press **AUTO** once lightly so that the control mode indication changes back to “**MANUAL**.”

Press **II** once or twice so that the control parameter indication changes to “**M.RNG ◆**.”

#### 5.2.14.4. Manual Selection of Basic Ranges on Customizable Display

It is assumed that both the **MAIN DISP** and **CTM DISP** menus are currently turned off. If they are being displayed now, press **FUNC** to turn them off.

Press **II** once or twice so that the control parameter indication changes to **“CTM.RNG ◆.”**

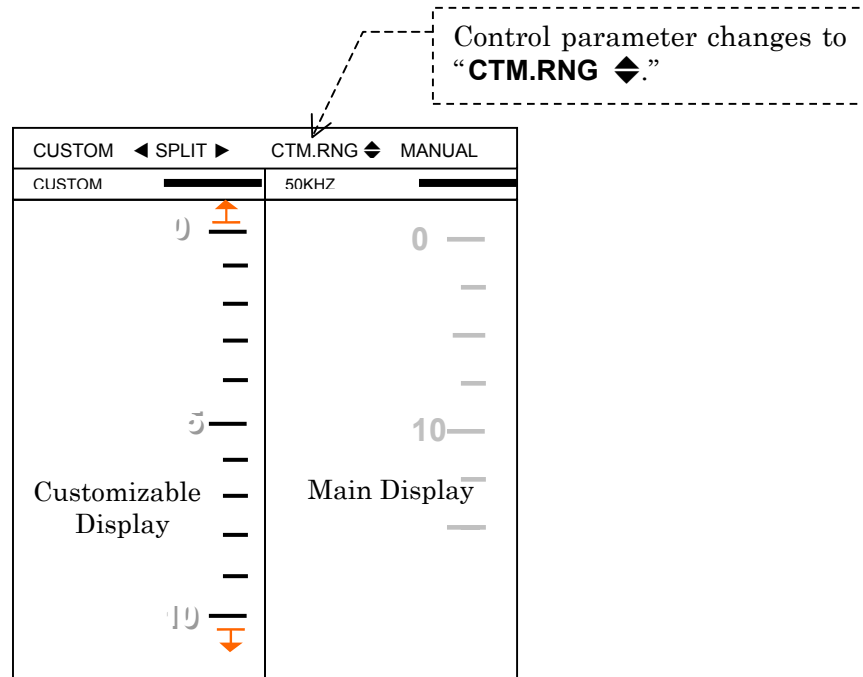

Press **▲** / **▼** to select the desired range.

The depth range setting on the main display will not be affected.

*NOTE: The “AUTO RANGE” or “FULL AUTO” mode of operation across the customizable display is not supported and cannot be activated.*

## 5.2.15. Phasing Up/Down Basic Range across Split Display

### 5.2.15.1. Manually Phasing Up/Down Basic Range on Main Display

It is assumed that both the **MAIN DISP** and **CTM DISP** menus are currently turned off. If they are being displayed now, press  to turn them off.

Press  once or twice lightly so that the control parameter indication just above the frequency readout on the main display reads “**M.SFT \* ◆**” as in the example below.

\* **M.SFT** = Main display shift

Under this condition, you will observe:

- that the set of scale lines on the main display is sandwiched between a pair of upward-oriented and downward-oriented arrow-like symbols, and
- that the scale calibration numbers on the customizable display become gray at the same time, indicating that depth range setting on that display is currently disabled.

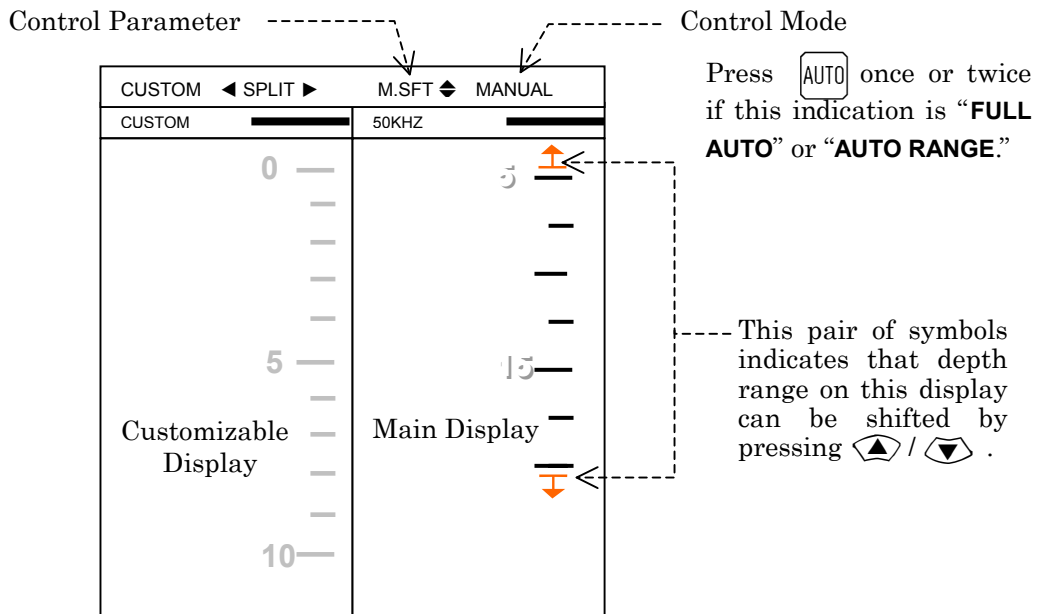

If the control mode indication reads “**FULL AUTO**” or “**AUTO RANGE,**” disable the automatic function by lightly pressing  once or twice so that the indication changes to “**MANUAL.**”

Press  /  to shift the current basic range.

The depth range setting on the customizable display will not be affected.



## 5.2.16. Selecting Display Modes on Main Display

### 5.2.16.1. Introduction

It is assumed that both the **MAIN DISP** and **CTM DISP** menus are currently turned off. If they are being displayed now, press **FUNC** to turn them off. The following display modes are selectable in sequence by repeatedly pressing **MODE** :

- (A) Single frequency (50 kHz or 200 kHz) normal display mode
- (B) Single frequency split display with pelagic expansion (mid-water expansion)
- (C) Single frequency split display with bottom-locked expansion
- (D) Dual frequency split display

(A)

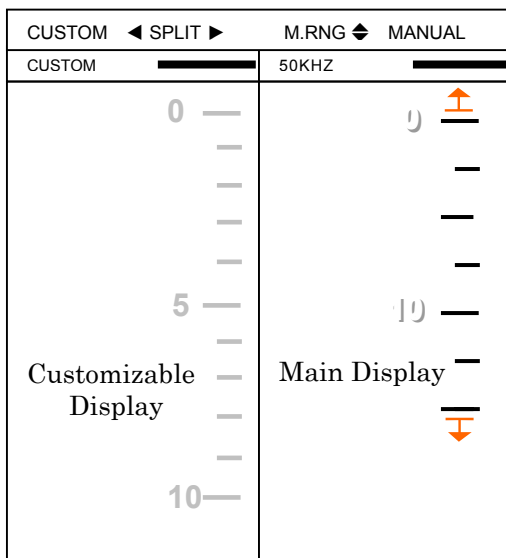

(B)

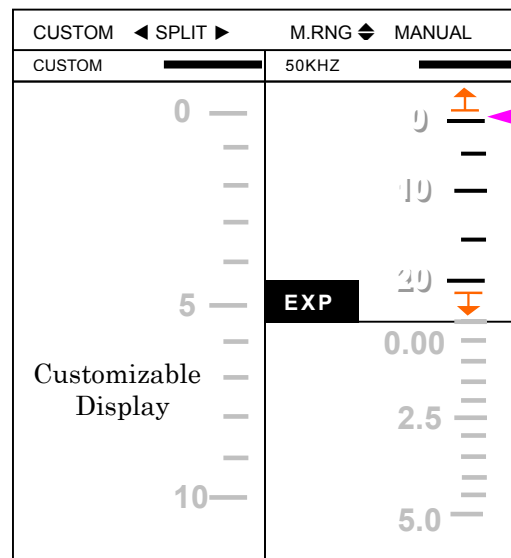

(C)

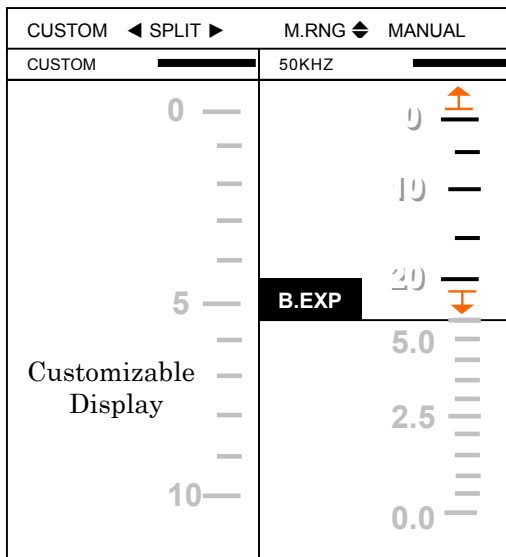

(D)

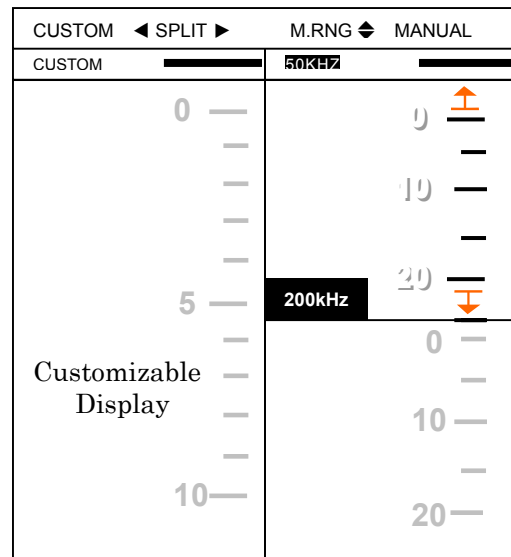

### 5.2.16.2. Selecting Expansion Ranges on Main Display



Press  once or twice so that the scale lines and calibration numbers on the expansion display show in white, while those on the other two displays are in gray.

The control parameter indication should then read “**SUB.RNG \***” as in the example at right.

\* **SUB.RNG** = sub range

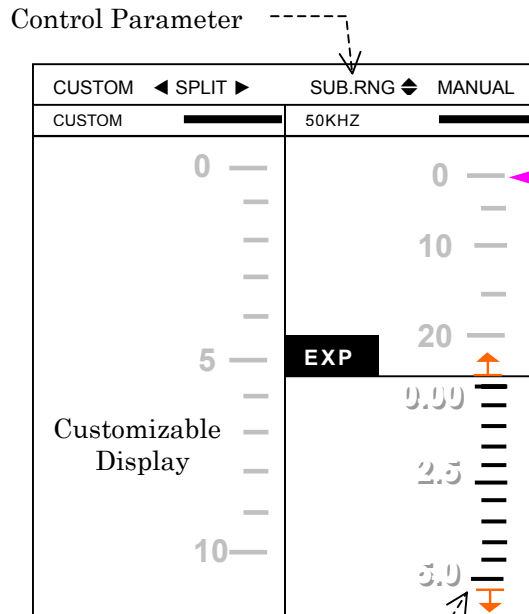
Press  /  to select the desired range.



The expansion range can be changed by pressing  / .

### 5.2.16.3. Phasing Up/Down Pelagic Expansion Ranges on Main Display

When the pelagic expansion (mid water expansion) mode is activated with , the current expansion range can be phased up/down via the following steps:

Press  once or twice so that the scale lines and calibration numbers on the expansion display show in white, while those on the other two displays are in gray.



The control parameter indication should then read “**SUB.SFT \***” as in the example at right.

\* **SUB.SFT** = sub range shift

Press  /  to shift the current range.

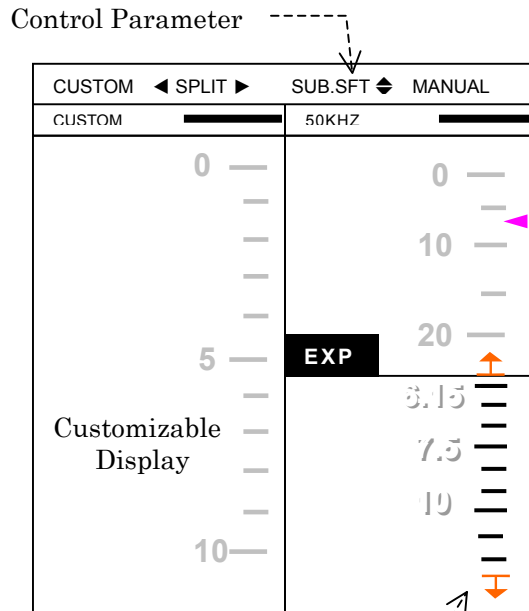
The  symbol in the upper half area represents the upper limit of the expansion range.



The expansion range can be shifted by pressing  / .

**5.2.16.4. Switching Frequency on Main Display**

To switch the operating frequency between the upper and lower displays during dual frequency operation, simply press (ENT) . A second keypress reverses the frequencies.

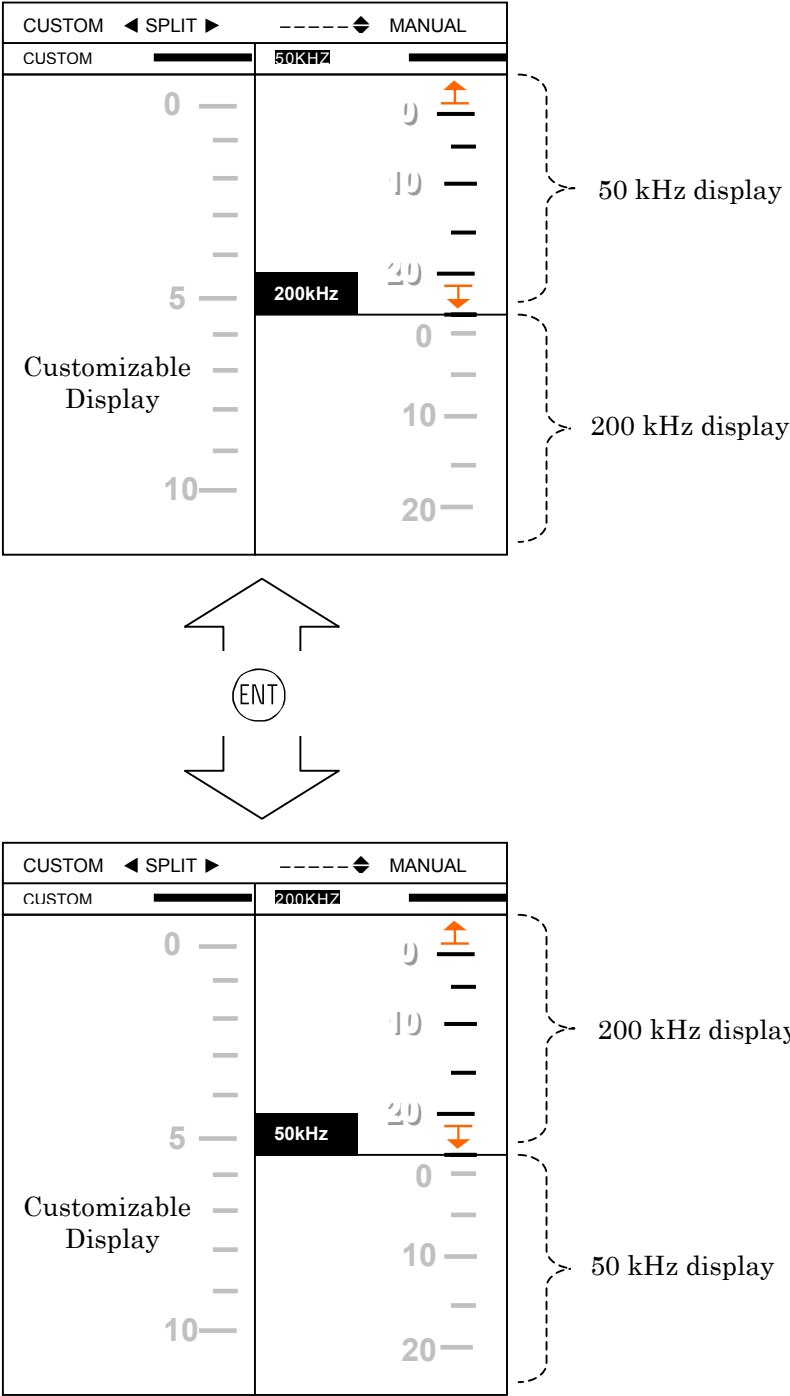

5.2.17. **Shifting the Partition**

The partition between the main display and the customizable display can be shifted to widen one display while narrowing the other, as illustrated below. It is assumed that both the **MAIN DISP** and **CTM DISP** menus are currently turned off. If they are being displayed now, press **FUNC** to turn them off.

-  : Shifts the partition to the right, widening the customizable display area.

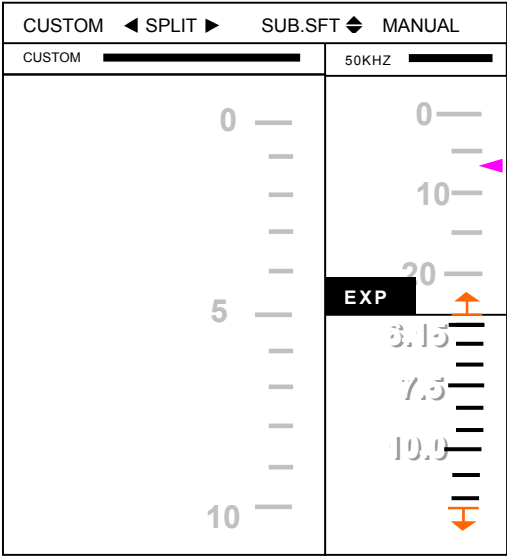

Widened Customizable Display

-  : Shifts the partition to the left, widening the main display area.

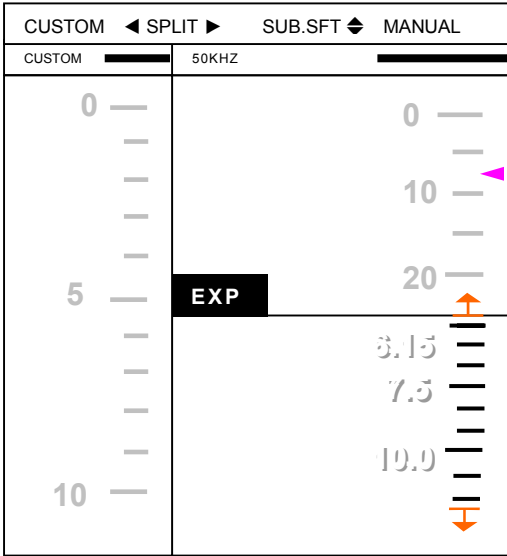

Widened Main Display

*NOTE: This function is valid for all display modes on the main display.*

## 5.2.18. Operation in High Sounding Rate Mode

### 5.2.18.1. Activating High Sounding Rate Mode

The high sounding rate mode of operation allows you to operate the equipment at twice the normal sounding rate available for the depth range in use, and is suitable for applications where you are looking for fast-moving objects, or where you are traveling at high speeds.

It is assumed that both the **MAIN DISP** and **CTM DISP** menus are currently turned off. If they are being displayed now, press  to turn them off.

The high sounding rate mode can be activated by pressing and holding down  for two seconds or longer. The on-screen operating mode indication should read “**HI-SPEED,**” as in the example below.

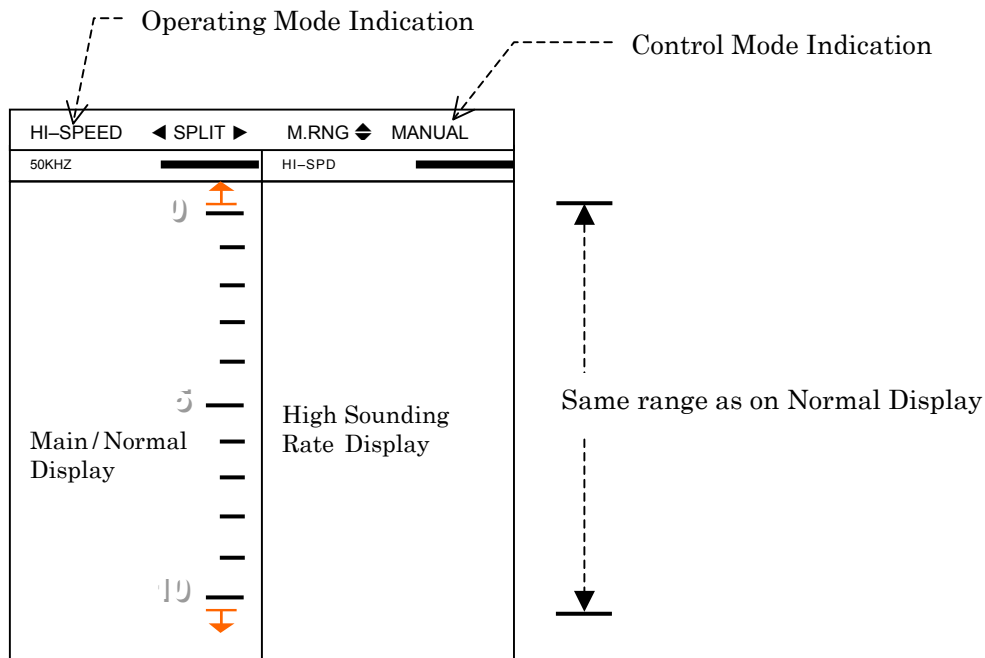

The screen will be split in two, with the normal rate operation across the left-hand display (main/normal display) and high sounding rate mode operation across the right-hand display (high sounding rate display), as in the example above.

#### Returning to Previous Screen

To return to the previous screen (normal sounding rate/full or split display), press and hold down  again for two seconds or longer.

### 5.2.18.2. Display Mode Selection across Main/Normal Display

Repeatedly pressing **MODE** selects the following display modes in sequence across the main/normal display:

- (A) Single frequency normal display
- (B) Single frequency split-screen display with pelagic expansion (zooming)
- (C) Single frequency split-screen display with bottom-locked expansion
- (D) Dual frequency split-screen display

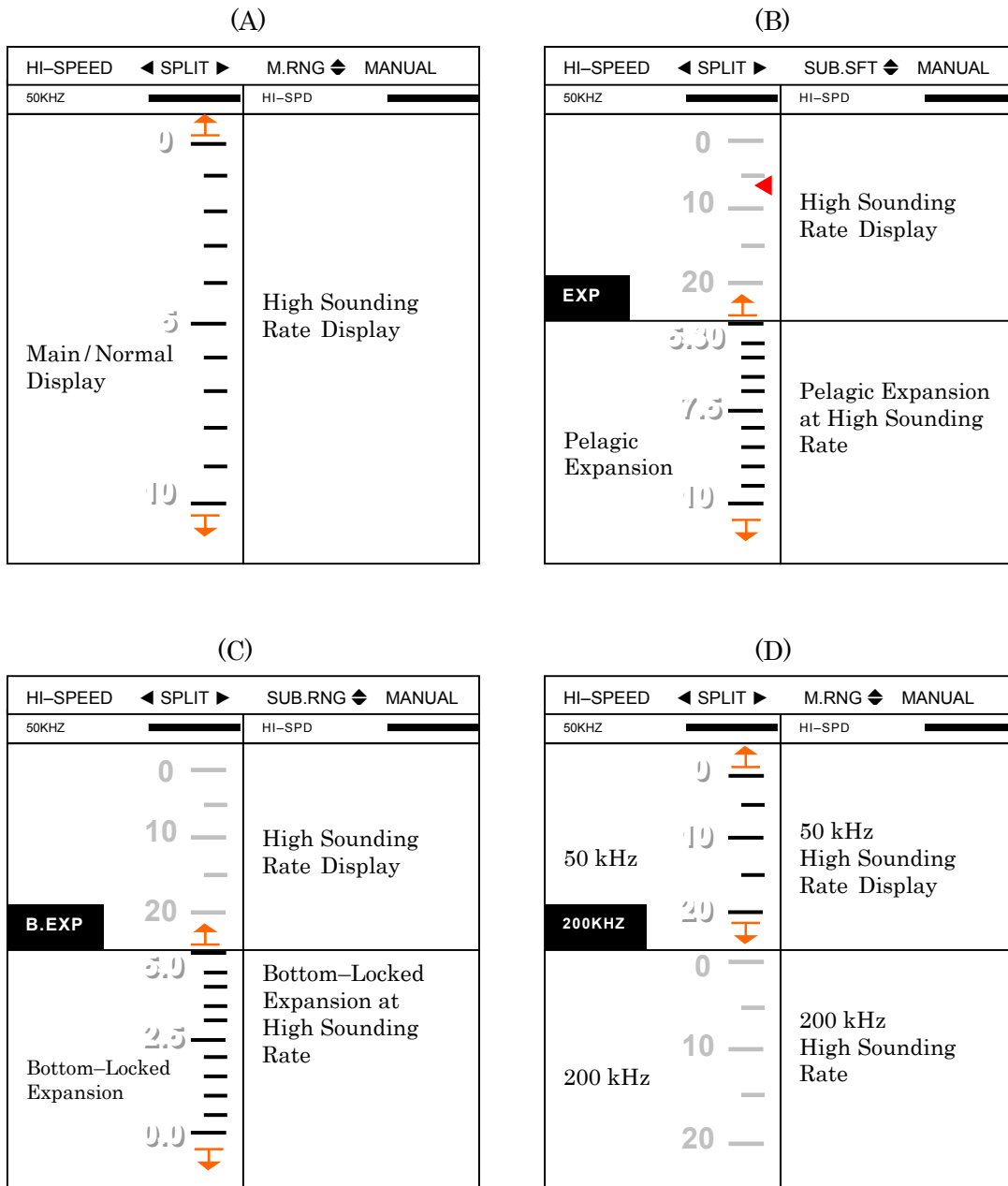

### 5.2.18.3. Selecting Basic Ranges across Main/Normal Display

The depth range across the right-hand display (high sounding rate display) is the same as on the left-hand display (main/normal display), and cannot be set separately across both displays.

Press  once or twice so that the scale lines and calibration numbers on the normal display show in white, while those on the other two displays are in gray.

The control parameter indication should then read “**M.RNG\***” as in the example at right.

\* **M.RNG** = main range

Press  /  to select the desired range.

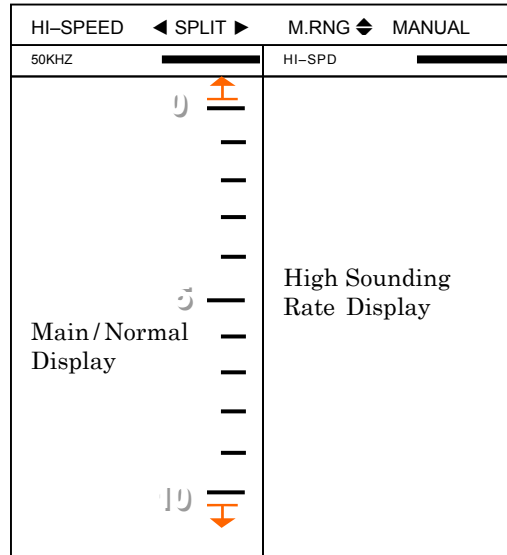

### 5.2.18.4. Selecting Expansion Ranges across Main/Normal Display

Press  once or twice so that the scale lines and calibration numbers in the expansion display area on the normal display show in white, while those on the other two displays are in gray.

The control parameter indication should then read “**SUB.RNG\***” as in the example at right.

\* **SUB.RNG** = sub range

Press  /  to select the desired range.

The same range setting applies to the right-hand display.

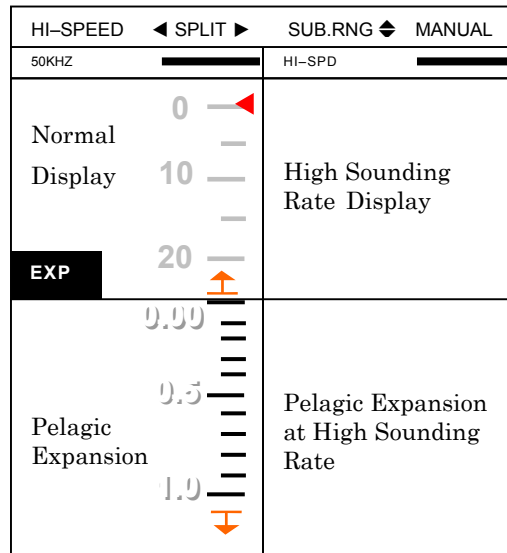

*NOTE: The expansion ranges on the bottom-locked expansion display can also be selected in the same manner.*

### 5.2.18.5. Phasing Up/Down Expansion Range across Main/Normal Display

Press  once or twice so that the scale lines and calibration numbers in the expansion display area on the normal display show in white, while those on the other two displays are in gray.

The control parameter indication should then read “**SUB.SFT \***” as in the example at right.

\* **SUB.SFT** = sub range shift

Press  /  to shift the current range up/down.

The  symbol on the normal display represents the upper limit of the expansion range.

HI-SPEED	◀ SPLIT ▶	SUB.SFT ◆	MANUAL
50KHZ			
Normal Display			High Sounding Rate Display
0			
10			
20			
<b>EXP</b>			
5.30			
7.5			
10			
Pelagic Expansion			Pelagic Expansion at High Sounding Rate

The same range setting applies to the right-hand display.

### 5.2.18.6. Switching Frequency on Main/Normal Display

To switch the operating frequency on the left-hand display during dual frequency operation, simply press . A second keypress reverses the frequencies.

HI-SPEED	◀ SPLIT ▶	M.RNG ◆	MANUAL
50KHZ			
0			
50 kHz			50 kHz High Sounding Rate Display
200KHZ			
0			
200 kHz			200 kHz High Sounding Rate



HI-SPEED	◀ SPLIT ▶	M.RNG ◆	MANUAL
200KHZ			
0			
200 kHz			200 kHz High Sounding Rate Display
50KHZ			
0			
50 kHz			50 kHz High Sounding Rate

### 5.2.18.7. Selecting Feed Rates

The echogram feed rate can be set separately across the right-hand (main/normal) and left-hand (high sounding rate) displays via the following instructions:

#### Feed Rate Selection on Main/Normal Display

It is assumed that no control menus are currently displayed. If they are showing, turn them off by pressing **FUNC**.

Press , opening the feed rate control window.

<b>MAIN DISP</b>	
PF	= 1/1

Press  /  to select the desired rate, while the window is open.

#### Feed Rate Selection on High Sounding Rate Display

Press **FUNC**. This opens a pair of control menus listing various parameters that can be set across each display, as in the example shown at right.



◀	<b>MAIN DISP</b>	▶
	PF = 1/1	
	GAIN = 40	
	STC = 0	
	NR = OFF	
	D.RNG= 5dB	

<b>HI. SPEED</b>
PF = 1/1

The parameters on the **MAIN DISP** menu are for the left-hand display (main/normal display). The parameter (PF) on the **HI.SPEED** menu is for the right-hand display (high sounding rate mode display).

Press  to activate the **HI.SPEED** menu. The menu title should then become red.

Press **ENT**.

Press  /  to select the desired feed rate, and then **ENT** to complete the selection.

Menu title is shown red

<b>HI. SPEED</b>
PF = 2/1



Close the menus by pressing **FUNC**, unless you wish to set other parameters on either display.

### 5.2.18.8. Setting Receiver Gain Level

The receiver gain level setting is common to both displays. The gain level on the high sounding rate display alone cannot be changed. It is assumed that the **MAIN DISP** and **HI.SPEED** menus are turned off. If they are currently showing, press **FUNC** to turn them off.

Press , opening the gain control window.

<b>MAIN DISP</b>	
GAIN	= 40

Press  /  to set the desired gain level, while the window is open.

### 5.2.18.9. Activating Automatic Gain Control Mode

It is assumed that the **MAIN DISP** and **HI.SPEED** menus are turned off. If they are currently showing, press **FUNC** to turn them off.

Press and hold down **◀** for two seconds or longer activates the automatic gain control mode (**AUTO GAIN**).

The control mode indication should then read "**AUTO GAIN**," as in the example at right.

To return to the manual gain control mode, press and hold down the same key again for two seconds or longer until the mode indication changes to "**MANUAL**."

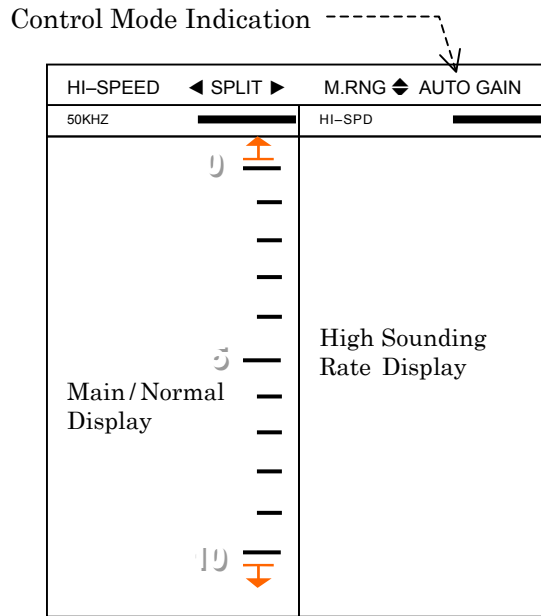

### 5.2.18.10. Setting STC Level

Press **FUNC**. This opens a pair of control menus listing various parameters that can be set across each display, as in the example shown at right.

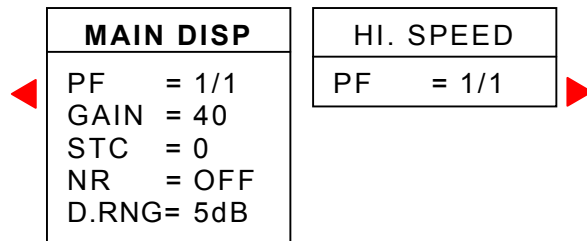

Press **◀** once so that the menu title "**MAIN DISP**" becomes red.

Using **▲** / **▼**, select option "**STC=XX**," and then press **ENT**. The option will be framed in red.

Repeatedly press **▲** / **▼** to obtain the desired STC level, and then **ENT** to complete the setting.

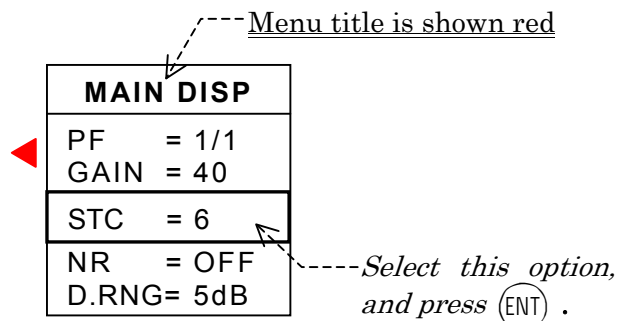

Close the menus by pressing **FUNC**, unless you wish to set other parameters on either display.

### 5.2.18.11. Selecting Noise Reduction (NR) Levels

Press **FUNC**. This opens a pair of control menus listing various parameters that can be set across each display, as in the example shown at right.

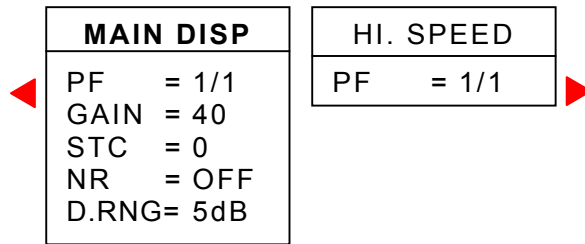

Press **◀** once so that the **MAIN DISP** menu becomes active (i.e. the menu title “**MAIN DISP**” becomes red).

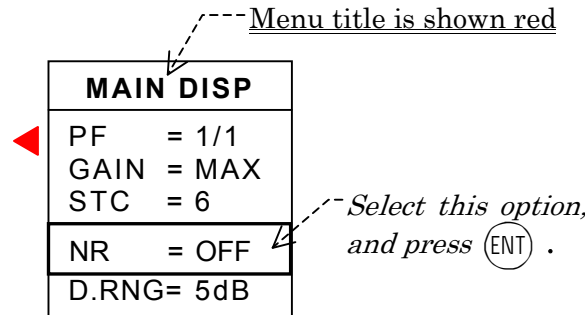

Using **▲** / **▼**, select option “**NR=X**,” and then press **ENT**. The option will be framed in red.

Repeatedly press **▲** / **▼** to obtain the desired NR level\*, and then press **ENT** to complete the setting.

\* Avoid **HIGH** level when looking for weak fish or bottom echoes.

Close the menus by pressing **FUNC**, unless you wish to set other parameters on either display.

### 5.2.18.12. Setting Echo Dynamic Range (D.RNG)

Press **FUNC**. This opens a pair of control menus listing various parameters that can be set across each display, as in the example shown at right.

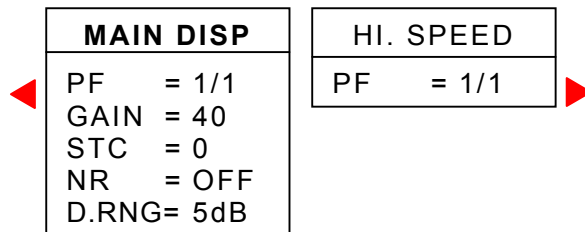

Press **◀** once so that the **MAIN DISP** menu becomes active.

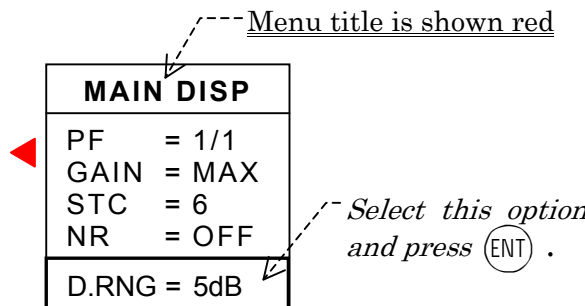

Using **▲** / **▼**, select option “**D.RNG=XdB**,” and then press **ENT**. The option will be framed in red.

Repeatedly press **▲** / **▼** to obtain the desired dynamic range, and then press **ENT** to complete the setting.



Close the menus by pressing **FUNC**, unless you wish to set other parameters on either display.



### 5.2.18.13. Setting Echo Threshold (T.HOLD) Level

#### Setting Echo Threshold Level on Main/Normal Display

It is assumed that both the **MAIN DISP** and **HI. SPEED** menus are currently displayed. If they are turned off, press **FUNC** to turn them on.

Press  once or twice so that the additional menu shows up over the **MAIN DISP** menu.

Using  / , select option “**T.HOLD**,” and then press **ENT**.

Press  /  to set the desired threshold level, and press **ENT** to complete the setting.

The current threshold level is indicated on the left-hand color sample scale.

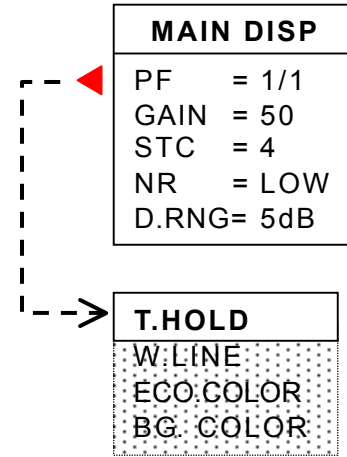

Press  to return to the **MAIN DISP** menu, unless you wish to set other parameters listed on the additional menu, or **FUNC** to close all menus.





#### Setting Echo Threshold Level on High Sounding Rate Display

It is assumed that both the **MAIN DISP** and **HI. SPEED** menus are currently displayed. If they are turned off, press **FUNC** to turn them on.

Press  once or twice so that the additional menu shows up over the **HI.SPEED** menu.

Using  / , select option “**T.HOLD**,” and then press **ENT**.

Press  /  to set the desired threshold level, and press **ENT** to complete the setting.

The current threshold level is indicated on the right-hand color sample scale.

Press  to return to the **MAIN DISP** menu, unless you wish to set other parameters listed on the additional menu, or **FUNC** to close all menus.

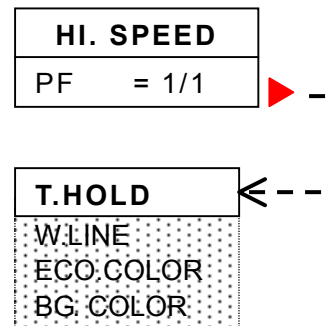





### 5.2.18.14. Setting White Line Level

#### Setting Echo Threshold Level on Main/Normal Display

It is assumed that both the **MAIN DISP** and **HI. SPEED** menus are currently displayed. If they are turned off, press **FUNC** to turn them on.

Press  once or twice so that the additional menu shows up over the **MAIN DISP** menu.

Using  / , select option “**W.LINE**,” and then press **ENT**.

Press  /  to set the desired white line level, and press **ENT** to complete the setting.

The current level is indicated on the left-hand color sample scale.

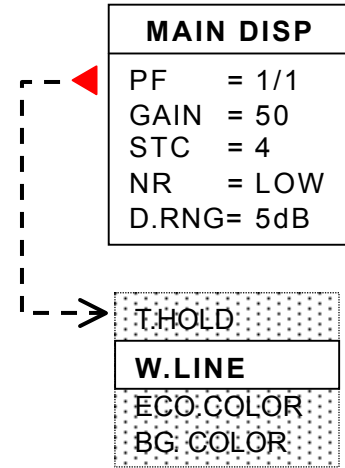

Press  to return to the **MAIN DISP** menu, unless you wish to set other parameters listed on the additional menu, or **FUNC** to close all menus.





#### Setting White Line Level on High Sounding Rate Display

It is assumed that both the **MAIN DISP** and **HI. SPEED** menus are currently displayed. If they are turned off, press **FUNC** to turn them on.

Press  once or twice so that the additional menu shows up over the **HI.SPEED** menu.

Using  / , select option “**W.LINE**,” and then press **ENT**.

Press  /  to set the desired white line level, and press **ENT** to complete the setting.

The current level is indicated on the right-hand color sample scale.

Press  to return to the **MAIN DISP** menu, unless you wish to set other parameters listed on the additional menu, or **FUNC** to close all menus.

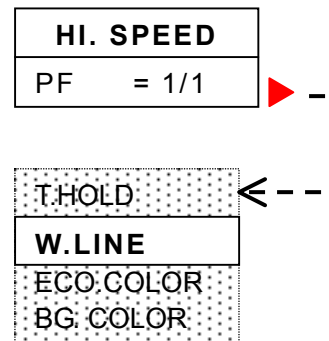





### 5.2.18.15. Changing Echo Color Assignments

#### Changing Echo Colors on Main/Normal Display

It is assumed that both the **MAIN DISP** and **HI. SPEED** menus are currently displayed. If they are turned off, press **FUNC** to turn them on.

Press  once or twice so that the additional menu shows up over the **MAIN DISP** menu.

Using  / , select option “**ECO.COLOR,**” and then press **ENT**.

Press  /  to select the desired color assignment pattern, and press **ENT** to complete the setting.

*The current assignments are shown on the left-hand color sample scale.*

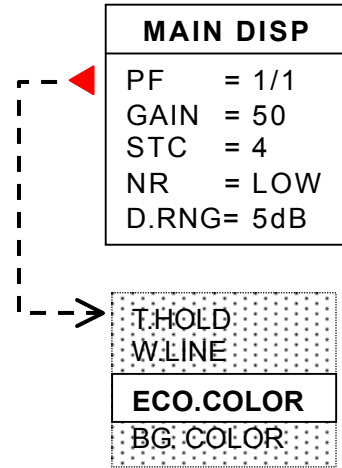

Press  to return to the **MAIN DISP** menu, unless you wish to set other parameters listed on the additional menu, or **FUNC** to close all menus.





#### Changing Echo Colors on High Sounding Rate Display

It is assumed that both the **MAIN DISP** and **HI. SPEED** menus are currently displayed. If they are turned off, press **FUNC** to turn them on.

Press  once or twice so that the additional menu shows up over the **HI.SPEED** menu.

Using  / , select option “**ECO.COLOR,**” and then press **ENT**.

Press  /  to select the desired color assignment pattern, and press **ENT** to complete the setting.

*The current assignments are shown on the right-hand color sample scale.*

Press  to return to the **MAIN DISP** menu, unless you wish to set other parameters listed on the additional menu, or **FUNC** to close all menus.

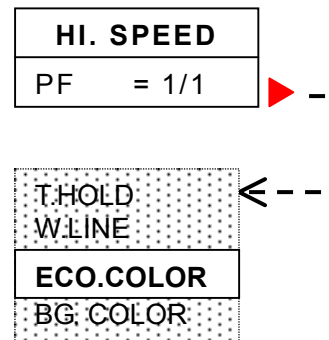





### 5.2.18.16. Selecting Screen Background Colors

#### Selecting Background Colors on Main/Normal Display

It is assumed that both the **MAIN DISP** and **HI. SPEED** menus are currently displayed. If they are turned off, press **FUNC** to turn them on.

Press  once or twice so that the additional menu shows up over the **MAIN DISP** menu.

Using  / , select option "**BG.COLOR,**" and then press **ENT**.

Press  /  to select the desired background color, and press **ENT** to complete the setting.

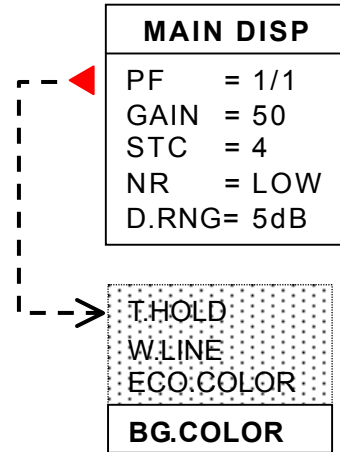

Press  to return to the **MAIN DISP** menu, unless you wish to set other parameters listed on the additional menu, or **FUNC** to close all menus.





#### Selecting Background Colors on High Sounding Rate Display

It is assumed that both the **MAIN DISP** and **HI. SPEED** menus are currently displayed. If they are turned off, press **FUNC** to turn them on.

Press  once or twice so that the additional menu shows up over the **HI.SPEED** menu.

Using  / , select option "**BG.COLOR,**" and then press **ENT**.

Press  /  to select the desired background color, and press **ENT** to complete the setting.

Press  to return to the **MAIN DISP** menu, unless you wish to set other parameters listed on the additional menu, or **FUNC** to close all menus.

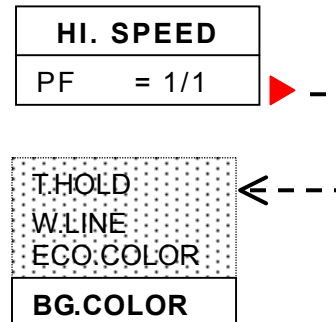

### 5.2.18.17. Shifting the Partition

The partition between the main/normal display and the high sounding rate display can be shifted by pressing  / .

## 6. Electrical Connections

### 6.1. Introduction

All electrical connections to the display unit are to be made via connector receptacles on the rear side of the cabinet. Some of the cables supplied as standard or with optional components have already been terminated in appropriate plugs, ready for immediate hook-up to the display unit. For cables that require plug termination, matching plugs are separately supplied.

### 6.2. Power Supply Connections

#### 6.2.1. Power Supply Requirements

The display unit is powered by an external DC power source between 11 and 40 volts. The power supply must be capable of continuously supplying at least 4A at 12 VDC or 2A at 24 VDC for proper start-up and reliable operation.

#### < CAUTION >

Use of a low current capacity supply or slow response supply, especially if it is a switch-mode regulator type, will produce an instantaneous voltage drop at power-up, making it impossible to turn the equipment on or resulting in erratic operation.

#### 6.2.2. Connections

A two-meter (6.5 ft) two-conductor fused cord is supplied for connection between the display unit and the power supply. The cord is terminated in a two-hole female type plug at one end, and open-ended at the other end, as illustrated below. The plug mates with the two-pin receptacle on the rear of the cabinet, and the two conductors (white and black) at the other end are to be connected to the ship's power source (battery terminals).

Figure 6-1 Standard Power Cord

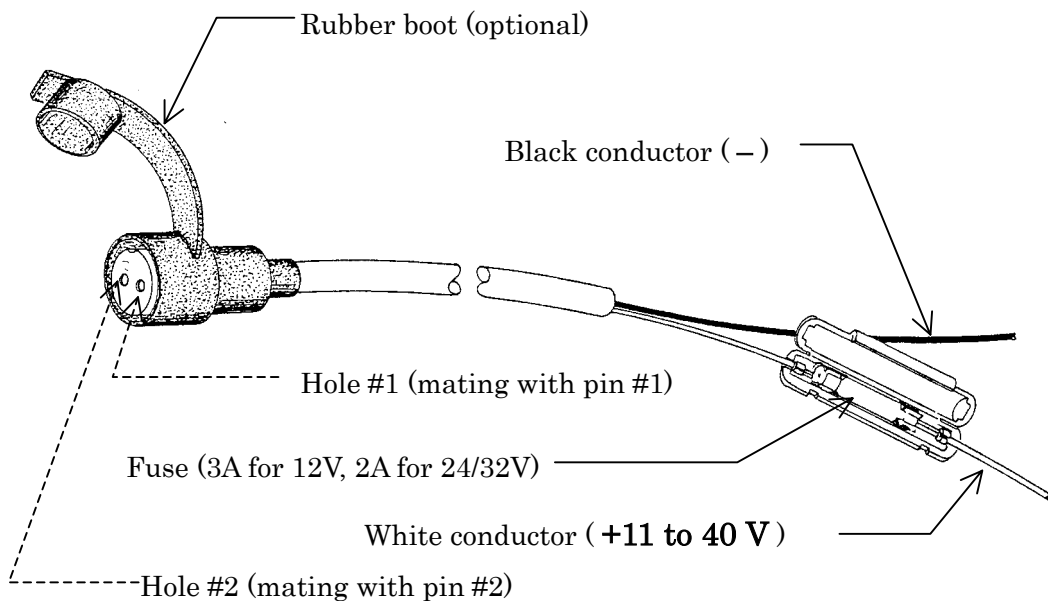

(continued on next page)

### 6.2.2. **Connections** (*continued – 2/2*)

Connect the two conductors to the ship's power supply system as follows:

- White conductor to positive (+) terminal
- Black conductor to negative (–) terminal

#### **< WARNING >**

**REVERSING THE POWER CORD POLARITY WILL BLOW THE FUSE THE INSTANT THE CORD IS PLUGGED INTO THE DISPLAY UNIT, EVEN IF THE UNIT IS SWITCHED OFF.**

### 6.2.3. **Power Cord Routing**

To minimize the chance of picking up extraneous electrical interference, it is highly recommended that the power cord be connected direct to the ship's power supply, and not via other terminals or power distribution board that are used in common with other on-board electronics. Ideally, the display unit should be powered by an independent power supply for best results.

### 6.2.4. **Installing the Fuse**

The power cord, illustrated in Figure 6–1, is usually delivered without a fuse installed in the in–line fuse holder. The appropriate fuse rating for the equipment depends on the power supply voltage as follows:

- **3A** (3 amperes) for operation off 12 VDC nominal
- **2A** (2 amperes) for operation off 24/32 VDC nominal

Two pieces of each rating are separately supplied. Open the in–line fuse holder, install the correct fuse in place, and close the holder.

Two pieces of slow–blow fuse are normally supplied for each amperage.

#### **< WARNINGS >**

- 1. BE SURE TO SWITCH THE EQUIPMENT OFF BEFORE INSTALLING THE FUSE.**
- 2. AN INCORRECTLY RATED FUSE OR INCORRECT TYPE FUSE WILL BLOW AT POWER–UP OR WILL NOT PROTECT THE EQUIPMENT IN THE EVENT OF A TROUBLE.**

### 6.2. **Grounding the Display Cabinet**

The display cabinet, which is electrostatically coated inside, can be grounded to the vessel's earth ground without grounding the negative line of the ship's power line. In situations where it is required, or desirable, to ground the cabinet for safety reasons or EMC compliance, connect from the wing-nut-fitted ground terminal on the rear panel to an appropriate earth ground in the vessel using a thick wire. The ground wire should be as short as possible to reduce the chance of picking up interference from other electronics.

### 6.3. Connections to the Transducer

The transducer is supplied with its integral cable (8m / 26ft standard). A three-hole female type is separately supplied for connecting the transducer to the display unit. With the aid of the illustration below, disassemble the plug, taking care not to lose the small screws.

**< WARNING >**

**DO NOT TURN THE EQUIPMENT ON WITH THE TRANSDUCER PLACED IN THE AIR, OR DAMAGE TO THE TRANSDUCER CRYSTAL WILL RESULT.**

#### Cable Extensions

In installations where the existing integral cable must be extended, be sure to use the same type of cable supplied by the manufacturer. Use of additional cable not approved by the manufacturer will seriously degrade the transducer performance. All joints must be made by soldering and properly insulated. "Twist-and-tape" connections must be avoided. **Coaxial cables cannot be used except for OEM versions.**

Figure 6-2 Soldering Plug to Transducer Cable

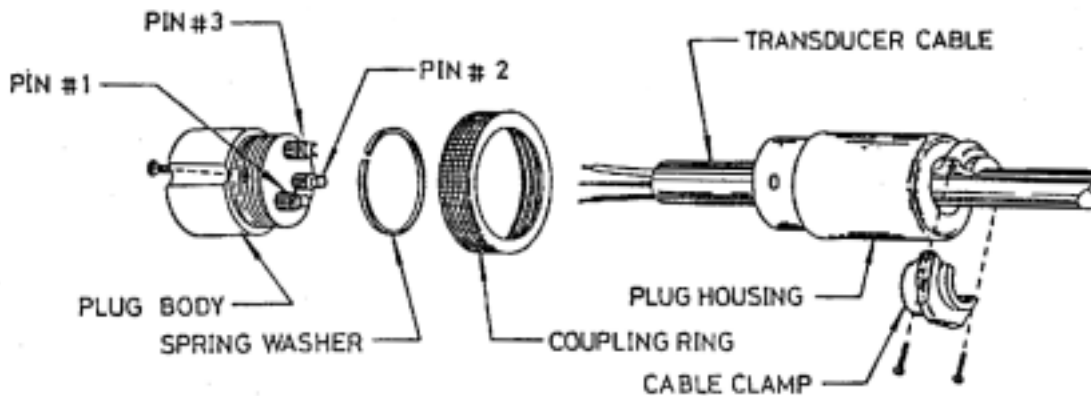

**Slide the plug housing over the cable first,** and solder the cable's conductors to the three pins on the plug body as follows:

- One conductor to pin #1
- Other conductor to pin #3
- Shield (braid) to pin #2

The pin ID numbers are marked in raised letters on the face of the plug body. Pins #1 and #3 are balanced, and may be reversed.

Care should be taken to ensure that no stray strands of wires or excess solder on any pin touches the inside of the plug housing when the plug is reassembled.

Reassemble the plug, tightening the screws firmly. The transducer can now be plugged into the three-prong receptacle on the rear panel of the display cabinet. Turn the equipment off, push the plug into the correct receptacle as far as it goes, and screw the coupling ring onto the plug body clockwise until it stops.

## 6.4. Connections to NMEA-0183

### 6.4.1. Introduction

The equipment is designed to interface with various types of external equipment that output or accept data signals in the NMEA-0183. The 8-pin jack on the rear panel is provided for this purpose, and an 8-hole female type mating plug is separately supplied for connections to such devices.

### 6.4.2. Types of Data To Be Transferred

The types of data that can be transferred between the display unit and external devices are as follows:

#### Outputs (TXD from display unit every 2 seconds)

- \$WIMTW (water temperature, *NOTE 1*)
- \$SDDBT (depth below transducer) or \$SDDBS (depth below surface, *NOTE 2*)
- \$SDDPT (depth below transducer with draft or keel offset)
- GPS-based data received from external sensor (e.g. \$GPGGA, \$GPVTG, *NOTE 3*)

#### Inputs (RXD to display unit)

- \$GPGGA (present position LAT/LON coordinates, *NOTE 4*)
- \$GPVTG (speed-over-ground and heading, *NOTE 5*)

#### *NOTES:*

1. *The \$WIMTW sentence will be output when the optional T-300 or T-400 temperature sensor is plugged into the 4-pin rear panel receptacle. Using a sensor other than the specified one will result in an incorrect temperature readout.*
2. *The \$SDDBT sentence will be output when the bottom is successfully detected. If a transducer draft is entered, the \$SDDBS will be output.*
3. *The output sentences are the same as those fed by an external GPS sensor.*
4. *This input will be used to display the present LAT/LON position.*
5. *This input will be used to display the present speed-over-ground and heading.*

### 6.4.3. Connector Pin Assignments

The pin assignments of the 8-pin I/O data receptacle on the rear panel are given below. The pin ID numbers, viewed from the plug side, are shown below. Connections should be made using a short length of good quality two-conductor shielded cable. To avoid interference, the shield should be grounded at both the display unit and external equipment connected. Use pin #8 for grounding the cabinet side.

Figure 6-3 ID Numbers of Pins in I/O Data Receptacle  
Viewed from Plug (Cable) Side



(continued on next page)

### 6.4.3. Connector Pin Assignments *(continued – 2/2)*

- Pin #1: RXD + (RX DATA +)
  - Pin #2: RXD – (RX DATA –)
  - Pin #3: TXD + (TX DATA +)
  - Pin #4:
  - Pin #5:
  - Pin #6:
  - Pin #7: 12VDC output, 200 mA maximum. See *NOTE* and **WARNING** #1 below
  - Pin #8: Chassis Ground (may be used as TXD - /TX DATA–)
- } NMEA–0183 data input from external GPS sensor  
 NMEA–0183 data output to external equipment  
 Reserved for system tests. Do not connect any device to this pin pair  
 Observe <**WARNING**> #2 below.

*NOTE: A 12V regulated DC voltage is available from pins#7 (+) and #8 (ground) for powering light-duty external devices, such as a GPS sensor.*

#### < WARNINGS >

- 1: THE DC OUTPUT IS CURRENT-LIMITED TO 1A FOR PROTECTION AGAINST A MOMENTARY SHORT. HOWEVER THE CURRENT DRAIN MUST NOT EXCEED 200 MA AT ANY TIME FOR CONTINUOUS-DUTY APPLICATIONS.**
- 2: PIN #4 IS TO BE USED TO ACTIVATE THE SOFTWARE UPDATING MODE. CONNECTING ANY DEVICE OTHER THAN THE SPECIFIED PROGRAMMING UNIT WILL CAUSE THE SYSTEM TO BE LOCKED UP.**

### 6.4.4. Connecting an External GPS Sensor

#### 6.4.4.1. Connections

If you wish to use an external GPS sensor that generates NMEA–0183 outputs, connect that device to the I/O data receptacle, as follows:

Table 6-1 External GPS Sensor Connections

Display Unit 8-pin I/O Data Receptacle	GPS Sensor (NMEA–0183)
Pin #1	TXD + (SD +)
Pin #2	TXD – (SD –) See <i>NOTE 1</i>
Pin #7	12 VDC + See <i>NOTE 2</i>
Pin #8	Ground

*NOTE: If you wish to power the GPS sensor via this pin, make sure that its current drain will not exceed 200 mA at any time. If the sensor or receiver is to be operated from an external power supply, the connection to this pin must be avoided.*

#### 6.4.4.2. Connections for Output Interfacing

The equipment outputs the following NMEA-0183 data every 2 seconds via the 8-pin I/O data receptacle:

- Water temperature (\$WIMTW)\*
- Depth below transducer (\$SDDBT) or depth below surface (\$SDDBS)
- Depth below transducer with draft or keel offset (\$SDDPT)
- Position, speed and heading data\*\* (\$GPGGA and \$GPVTG)

\* *Optional temperature sensor is required. See paragraph 6.5.*

\*\* *Optional GPS sensor is required. GPS-derived data sentences are output at intervals longer than 2 seconds.*

To derive the above outputs, connect the desired device to the display unit as follows:

Table 6-2 Connections to Derive Outputs

Display Unit 8-pin I/O Data Receptacle	NMEA-0183 Input Port on Track Plotter, PC, etc.
Pin #3	RXD + (RD +)
Pin #8	RXD - (RD -)

#### 6.5. Connecting Water Temperature Sensor

The 4-pin receptacle on the rear panel is provided to connect an optional T-300 or T-400 temperature sensor. The sensor has an integral shielded cable, normally terminated in a four-hole female-type mating plug. Table 6-3 at right shows the connections between the display unit and the temperature sensor.

Table 6-3 Water Temp. Sensor Connections

Display Unit 4-pin Temp. Receptacle	Temp. Sensor Cable
Pin #1	Center Conductor
Pin #2	Shield (braid)
Pin #3	No Connection
Pin #4	No Connection

Figure 6-4 ID Numbers of Pins in Water Temperature Sensor Receptacle  
Viewed from Plug (Cable) Side



## 7. Installation

### 7.1. Display Cabinet Installation

#### 7.1.1. General Precautions

The display cabinet is constructed to withstand humid and corrosive atmosphere normally encountered in the marine environment, but is not designed to be installed or operated outside the cabin. Serious damage will result to the electronics inside the cabinet when it is exposed to salt water spray. The LCD screen is prone to be damaged permanently if it is exposed to direct sunlight for more than 30 minutes continuously.

#### 7.1.2. Installation Site Requirements

For long term trouble-free service, the proposed site for installation should be:

- dry, well-ventilated and free as much as possible from shocks and engine vibrations.
- away as much as possible from areas of high temperatures or areas where the unit is likely to be exposed to direct sunlight.

The display unit weights approximately 1.75 kg (3.7 LBS) with the mounting bracket attached. Make sure that the mounting surface is strong enough to support the unit against shocks or vibrations that are likely to be encountered with the ship in motion.

#### < WARNINGS >

- 1. DO NOT PLACE THE UNIT IN AN UNVENTILATED, SEALED ENCLOSURE, SUCH AS A THEFT-DETERRENT CABINET, OR OVERHEATING AND DAMAGE WILL RESULT. DAMAGE CAUSED BY INSTALLING THE UNIT IN AN UNVENTILATED ENVIRONMENT WILL NOT BE COVERED BY THE MANUFACTURER'S WARRANTY.**
- 2. DAMAGE CAUSED BY EXPOSURE TO WATER SPRAY OR TO DIRECT SUNLIGHT WILL NOT BE COVERED BY THE MANUFACTURER'S WARRANTY.**

#### 7.1.3. Installing the Display Unit

The display unit is designed to be mounted on a tabletop with the mounting bracket supplied, as in the example below. The cabinet dimensions are given in Figure 7-1. Secure the bracket to the site selected, using a set of four appropriate wood screws.

Overhead mounting is also possible where space limitation does not allow table-top mounting. See the instructions on next page.

*(continued on next page)*

### 7.1.3. Installing the Display Unit (continued - 2/2)

Figure 7-1 V-6202 Cabinet Dimensions

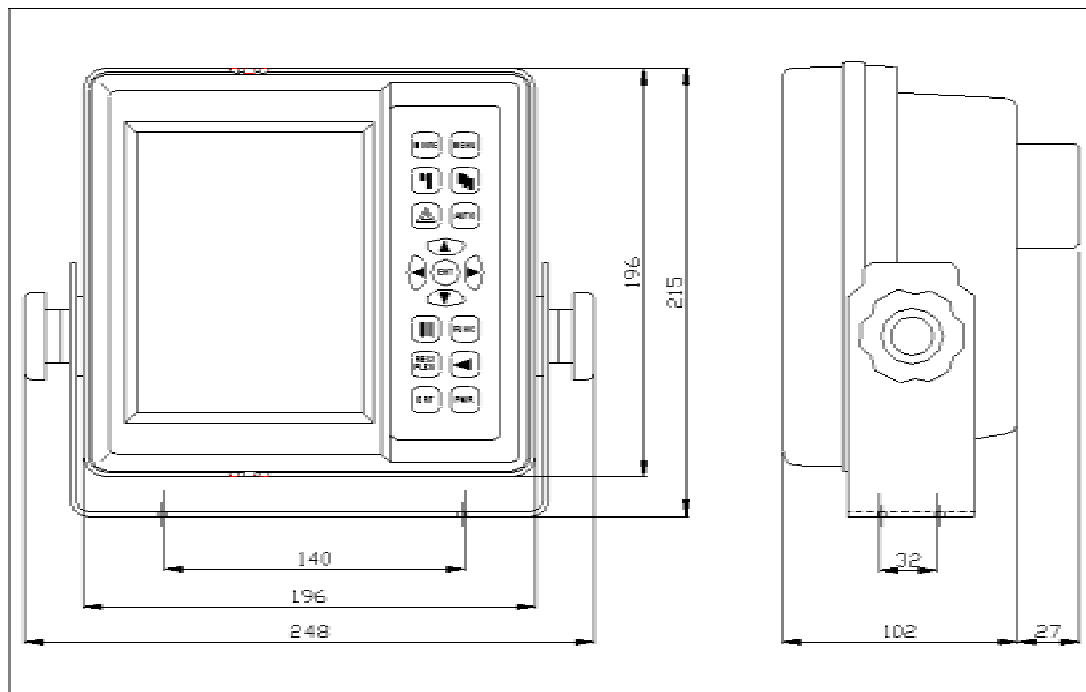

*NOTE: Dimensions are in millimeters.*

Weight: Approx. 1.75 kg with mounting bracket attached

#### Overhead Mounting

To mount the unit overhead, turn the rear section of the cabinet upside down via the following procedure:

- (1) Remove a total of 8 small pan-head screw\*/washer sets that secure the rear section of the cabinet to the aluminum rear panel, while taking care not to lose any of them.  
\* *machine screw, 3×8 mm*
- (2) Remove a total of 8 large pan-head screws (self-threading, 4×24 mm) that secure the rear section to the front section, while taking care not to lose any of them. The rear section can now be detached from the front section.
- (3) Turn the rear section upside down, and install it again to the front section with the large pan-head screws. *Do not overtighten the screws, or the threaded holes will be destroyed.*
- (4) Re-install the 8 small screws, securing the rear panel to the rear cabinet section. *Do not overtighten the screws.*

## 7.2. Transducer Installation

### 7.2.1. Introduction

The installation should be planned in advance, keeping in mind the standard cable length connected to the transducer. In an installation where a longer cable is required, it is recommended that the transducer be ordered, specifying the desired length for its integral cable, instead of extending the existing cable with an additional cable. If the existing cable has to be extended, be sure to use the same type of cable (two-conductor shielded type) supplied by the manufacturer.

Since the transmitter output is electrically balanced, **coaxial cables cannot be used for extension purposes.**

### < CAUTION >

**Use of extension cable that is not approved by the manufacturer can seriously degrade the depth performance of the transducer.**

### 7.2.2. Matched Transducer

The equipment is designed to match the following transducer:

- Radarsonics 201-50/200 bronze-molded single-element PZT ceramic  
Standard cable length: 8 meters (26 feet)  
Beam width at half-power points: 45° at 50 kHz, 11° at 200 kHz

### 7.2.3. Installation Location

The installation location and method of installation seriously affect the echo detection capability of the equipment. Careful consideration must, therefore, be given to selecting the mounting location and deciding the method of installation that best suit the vessel. Air bubbles and turbulent streams, which are caused when the vessel is in motion, will most seriously degrade the depth performance. The transducer should, therefore, be located well clear of any water intake/discharge line and also clear of any projections along the hull that might disturb the smooth flow of water around the transducer.

On deep-keeled vessels, care must be taken to ensure that the energy beam of the transducer will not be blocked by the keel.

Although the appropriate mounting location depends on the type of the vessel and its normal cruising speeds, a practical choice will be somewhere between 1/3 and 1/2 of the vessel's length from the fore. To minimize the influence of noise from the propellers, it is recommended that the transducer be mounted so that its face is inclined toward the fore within 5 degrees from vertical.

Leveling blocks may be designed accordingly to meet this requirement. Note that the more the transducer protrudes from the hull, the better the results will be.

*(continued on next page)*

7.2.3. **Installation Location** (*continued - 2/3*)

Figure 7-2 Recommended Transducer Location

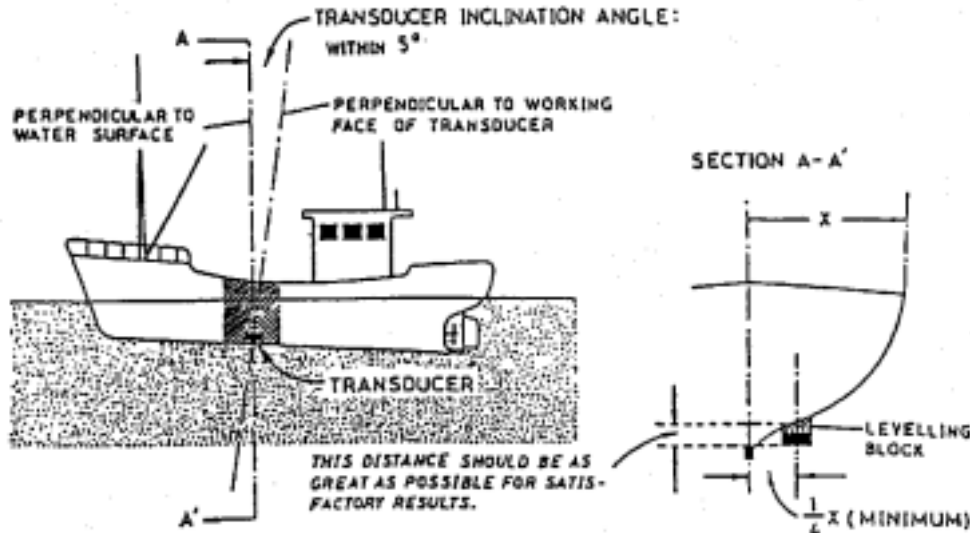

A typical through-hull installation is illustrated in Figure 7-3. The leveling blocks shown are to be supplied by the dockyard. Any gaps between the block and the transducer should be filled up with mastic, and the entire surface be made as smooth as possible to provide an undisturbed flow of water over the transducer face.

To ensure a watertight installation, apply a liberal amount of high quality sealing compound inside the mounting hole, over the threaded stem of the transducer. However, do not paint the transducer face, or decreased sensitivity will result.

Transom Mounting

We do not recommend mounting the transducer on the transom, if the equipment is going to be used for commercial fishing. Although popular with small boats because of not having to drill a hole through the hull, transom mounting will place the transducer in the middle of turbulent streams caused by the propellers, and will seriously degrade the depth detection performance. The manufacturer will not be responsible for poor results obtained from this type of mounting.

Inside-the-Hull Mounting

Mounting the transducer inside the hull should be avoided for fish finding applications, even if it is to be placed in a liquid-filled vessel. The ultrasonic energy transmitted from the transducer and echoes will be greatly attenuated by the planking, resulting in extremely poor depth performance. The manufacturer will not be responsible for poor results obtained from this type of mounting.

7.2.3. **Installation Location** (*continued - 3/3*)

Figure 7-3 below shows a typical through-hull installation of the standard transducer. The leveling blocks shown must be supplied by the dockyard.

Figure 7-3 Through-Hull Installation of Standard Transducer

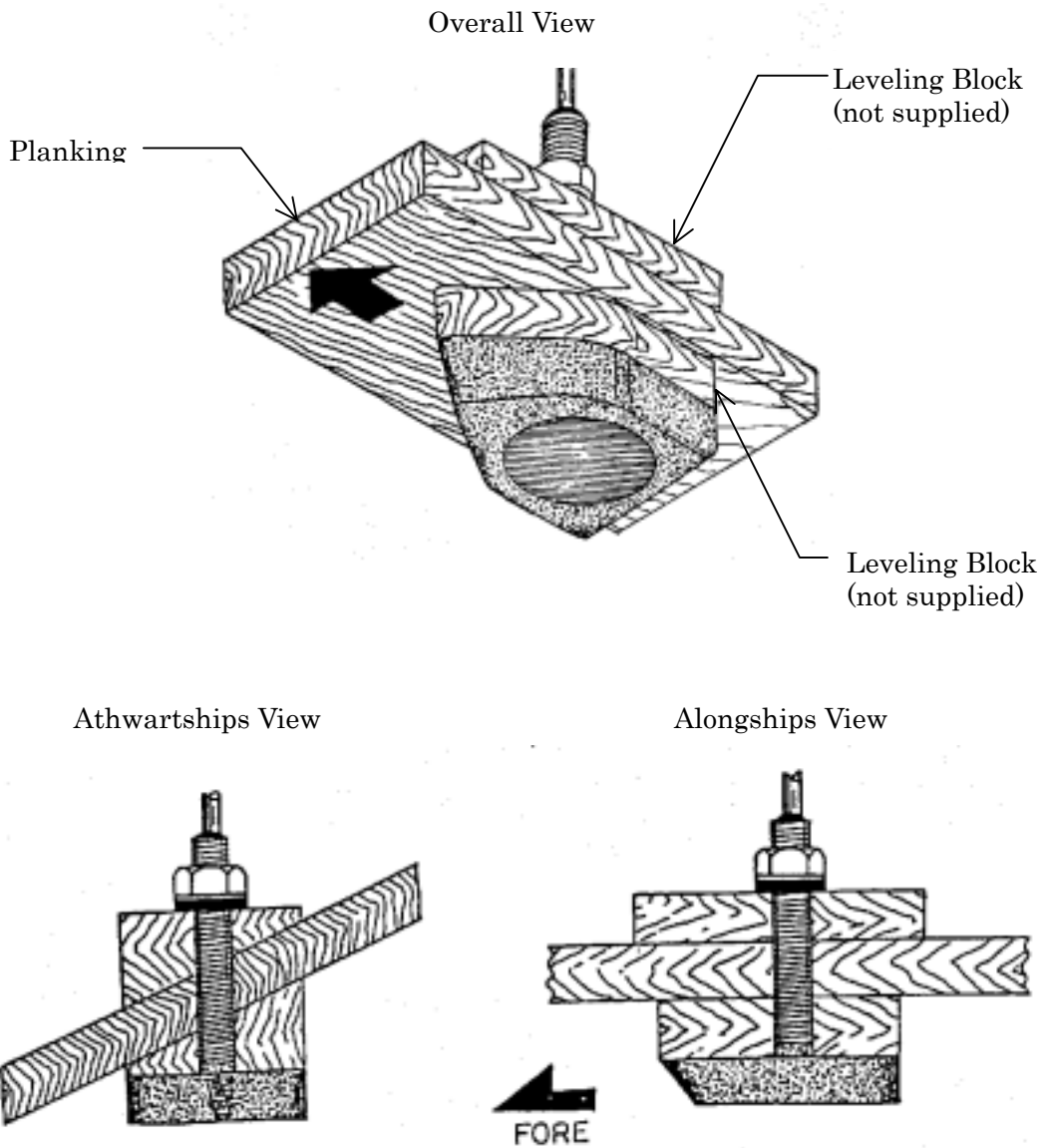

The transducer dimensions are given in Figure 7-4 on next page.

7.2.4. Transducer Dimensions

All dimensions are in millimeters.

Figure 7-4 Radarsonics Type 201-50/200 Dual Frequency Transducer

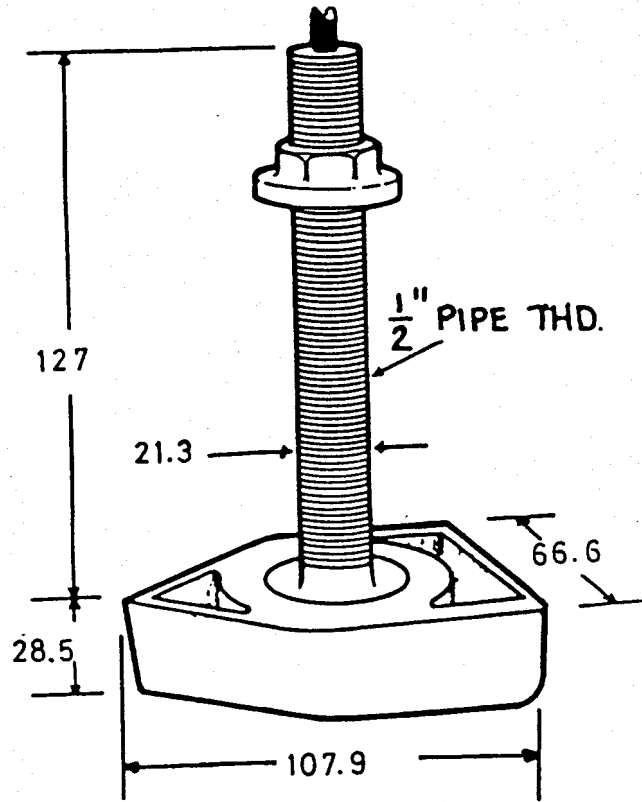

Dimensions in Inches

127.0 mm	5"
107.9 mm	4.25"
66.6 mm	2.62"
28.5 mm	1.12"
21.3 mm	0.84"

Weight: Approx. 1.36 kg (3 LBS)

Cable Length: 8 meters (26 ft) standard